



Engineering & Planning

14900 Interurban Ave. S
Suite 279
Seattle, WA 98168-4635
Ph: 206.674.4659
www.patrickharron.com

Yusen Residence
3246 72nd Pl. SE
Mercer Island, WA 98040

STORM DRAINAGE REPORT

Prepared for:
David & Caitlin Yusen
3246 72nd Place SE
Mercer Island, WA 98040
davidyusen@outlook.com

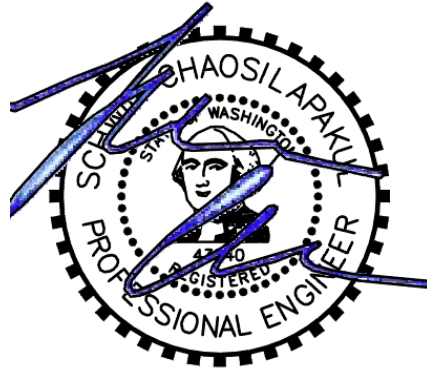

Prepared by:
Nick Millman, E.I.T.
Schwin Chaosilapakul, P.E.
Patrick Harron & Associates, LLC
14900 Interurban Avenue S., #279
Seattle, WA 98168
206.674.4659

PHA Project #: 25113
Date: December 12th, 2025
Revised: April 7th, 2026
Revised: April 24th, 2026

Yusen Residence
Storm Drainage Report

TABLE OF CONTENTS

1. PROJECT OVERVIEW	1
2. EXISTING CONDITIONS	3
3. PROPOSED CONDITIONS:	4
4. INFILTRATION FEASIBILITY ASSESSEMENT AND INFILTRATION BMP DESIGN.....	11
5. OFF-SITE CAPACITY ANALYSIS	11
6. HYDROLOGIC/HYDRAULIC ANALYSIS	12

LIST OF APPENDICES

Appendix A – Stormwater Site Plan	
Appendix B – Downstream Pipe Capacity	
Appendix C – Geotechnical Report	
Appendix D – Construction Stormwater Pollution Prevention Plan (CSWPPP)	
Appendix E – Operations & Maintenance Manual	

LIST OF FIGURES

Figure 1 – Vicinity Map	1
Figure 2 – Existing Conditions Exhibit	3
Figure 3 – Developed Conditions Exhibit.....	4
Figure 4 – Requirement for Redevelopment Flow Chart.....	6
Figure 5 – LID Flow Chart	7
Figure 6 – Downstream Map.....	11

Yusen Residence
Storm Drainage Report

1. PROJECT OVERVIEW

This Storm Drainage Report is submitted as supporting documentation for all permits as required by the City of Mercer Island for the construction of the proposed Yusen Residence.

This report was prepared in accordance with the 2019 Department of Ecology Stormwater Management Manual for Western Washington (DOE SWMMWW) as adopted by the City of Mercer Island.

The following tabulates the project site data:

Address:	3246 72 nd Pl. SE Mercer Island, WA 98040
Parcel Number:	130030-0840
Total Property Area:	16,650 sf (0.38 acres)
Project Site Area (Onsite):	11,987 sf (0.28 acres)
Project Site Area (Offsite):	1,670 sf (0.04 acres)
Zoning:	R-8.4 Single Family
Drainage Basin:	Lake Washington

Figure 1 – Vicinity Map

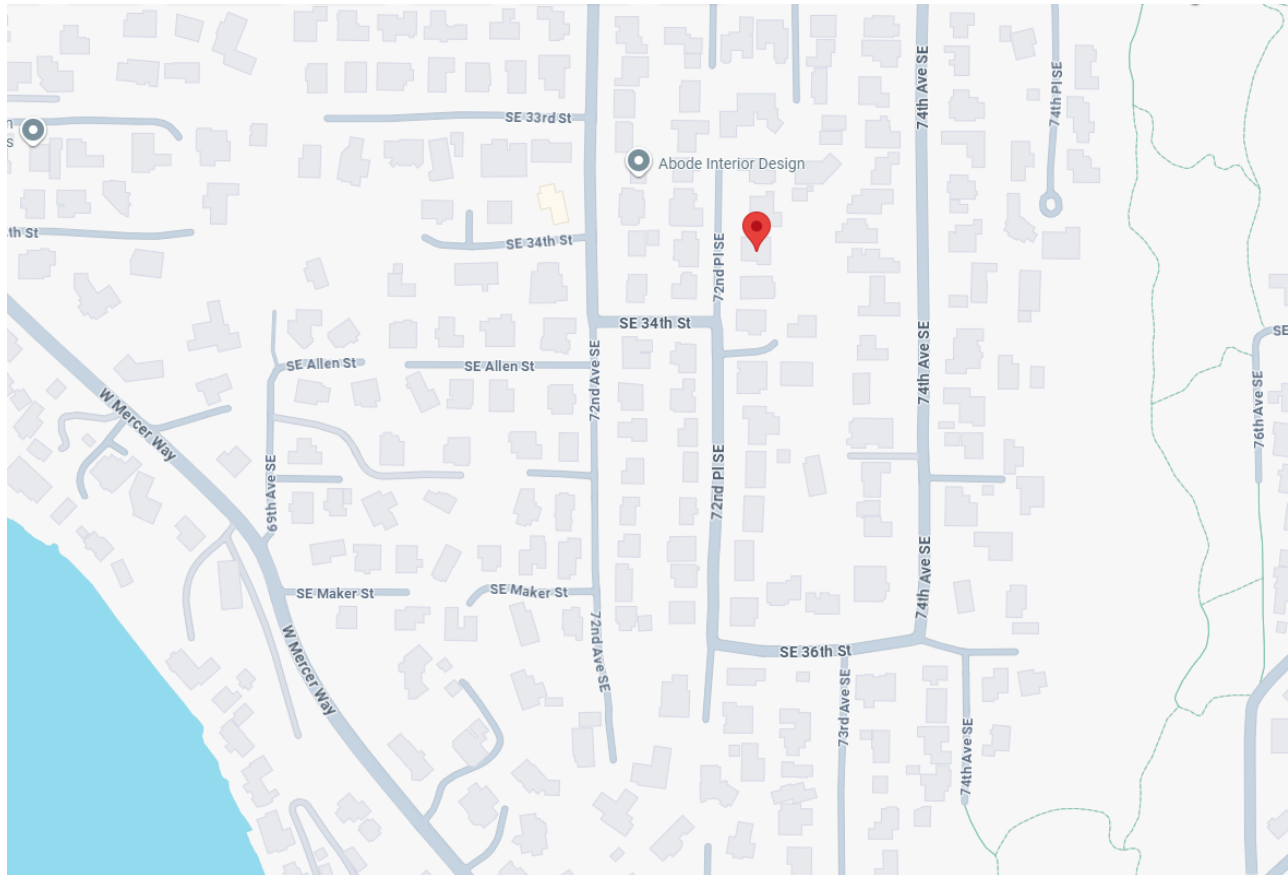

More generally the site is located within the SW 1/4 of Section 12, Township 24 North, Range 4 East, Willamette Meridian, King County, Washington.

Project Description:

Please refer to *Figure 2 – Existing Conditions Exhibit* and *Figure 3 – Developed Conditions Exhibit* on the following pages to aid in the project description. Full Stormwater Site Plans are provided in *Appendix B*.

The project proposes to demolish the existing residence, balcony, driveway, and walkway to construct a new residence with attached garage, and driveway. Proposed stormwater management will consist of a direct connection to the existing storm system within 72nd Place NE to the west.

Site topography in the proposed condition will generally match existing conditions, with surface runoff leaving the site to the west, per site topography.

The following documents have been used as a basis for the proposed drainage design:

- 2019 DOE Stormwater Management Manual for Western Washington
- Topo and Boundary Survey by RYKA Land Services dated July 22nd, 2025.
- Architectural Plans by Sturman Architects dated September 12th, 2025.
- Geotechnical Report by Geotech Consultants, Inc. dated October 14th, 2025.

2. EXISTING CONDITIONS

The project site is rectangular in shape. The property is bounded by 72nd Pl. SE to the west and single-family homes to the north, south, and east. There is an existing residence on the property, with a paved driveway accessing 72nd Pl. SE.

The topography of the property slopes to the west at slopes of approximately 2 to 3%. Runoff enters the existing 72nd Pl SE storm system and flows southward and eastward. Onsite soils generally consist of silty sands, and infiltration is not recommended for the project site as specified in the Geotech Report included in Appendix C. Please refer to *Figure 2 – Existing Conditions Exhibit* below and *Figure 6 – Downstream Map* on page 11, as well as Section 5 – Offsite Capacity Analysis for details.

Figure 2 – Existing Conditions Exhibit

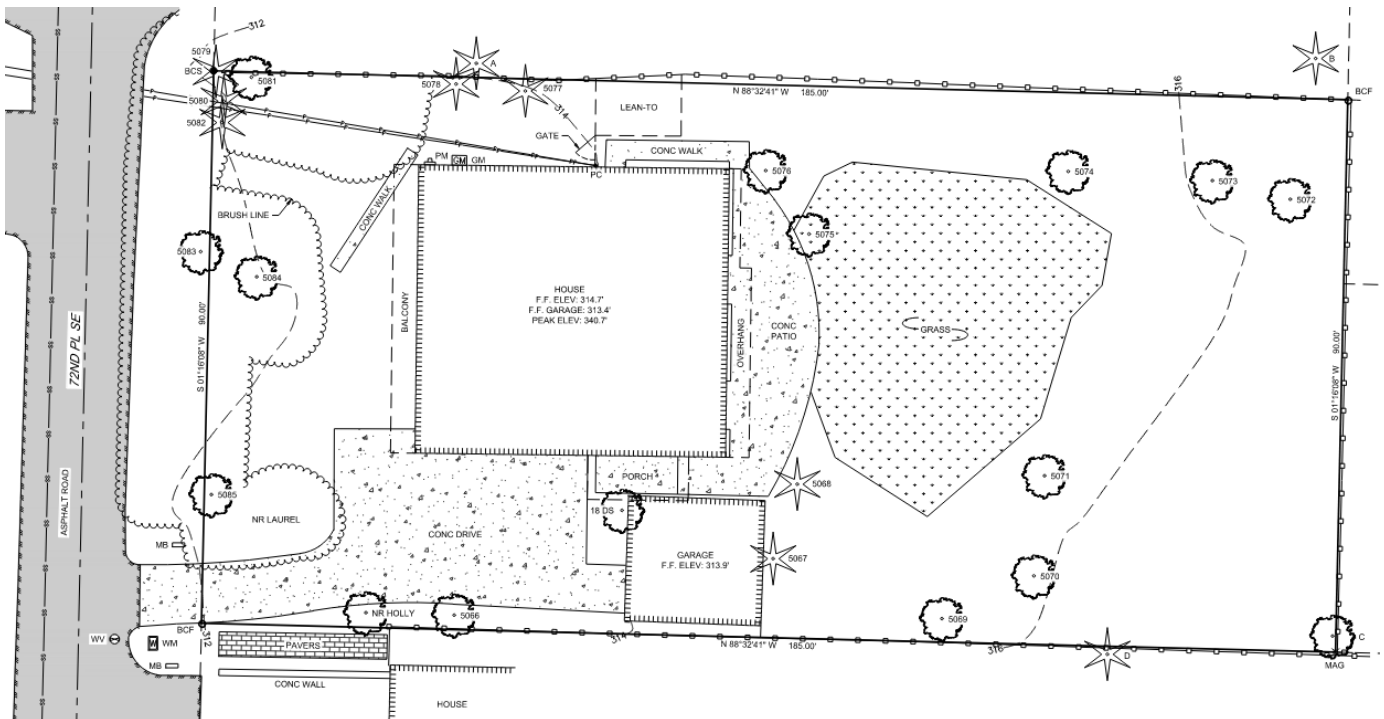

3. PROPOSED CONDITIONS:

Please refer to *Figure 3 – Developed Conditions Exhibit* below to aid in the project description.

The project proposes to demolish the existing residence, deck, and driveway, then construct a new single-family residence and garage, with a driveway and walkway accessing 72nd Pl. SE to the west.

A direct stub-out pipe connection to the existing storm system within 72nd Place is proposed via a new catch basin within the right-of-way due to infeasibility of other stormwater BMPs. Basement footing runoff will be directed to a stormwater sump pump system to be directed to a proposed catch basin in the southwest portion of the property before gravity draining to the existing storm system. See section 4 for details on infeasibility.

Figure 3 – Developed Conditions Exhibit

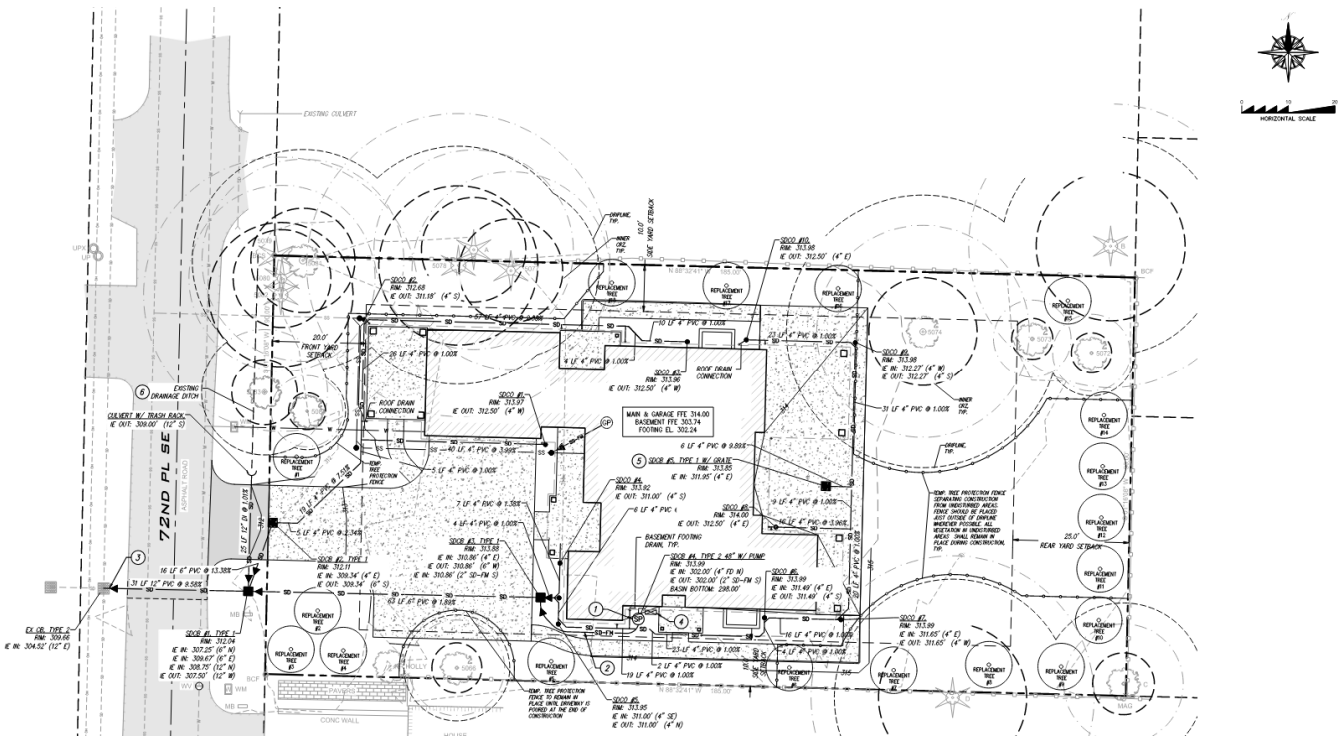

Project Area Summary

On-Site Area Inventory		
Description	Area (sf)	Area (ac)
Total Property Area	16,650	0.382
Residential Rooftop	4,352	0.100
Walkway / Patio	1,288	0.030
Driveway*	1,734	0.040
New + Replaced Hard Surfaces	7,374	0.169
Total Pervious (Lawn)	9,276	0.213

* Pollution-Generating Hard Surfaces (PGHS) = 1,734 sf

Project Regulation:

Please refer to *Section 6* for detailed calculations of areas to aid in the following discussion.

Requirements Determination

This project will create 7,374 square feet of new + replaced hard surface area per the proposed site layout. See the Project Area Summary above for details.

Per Figure 5 (Figure 1.5 of the SWES), **minimum requirements #1-9 will apply to this project** based on the proposed hard surface area.

Per Figure 6 (Figure 1.6 of the SWES), **BMPs on List #1 will be applied to the project.** (Refer to Section 6 for proposed BMPs).

Figure 4 – Flow Chart for Determining Requirements for Redevelopment:

Figure I-3.2: Flow Chart for Determining Requirements for Redevelopment

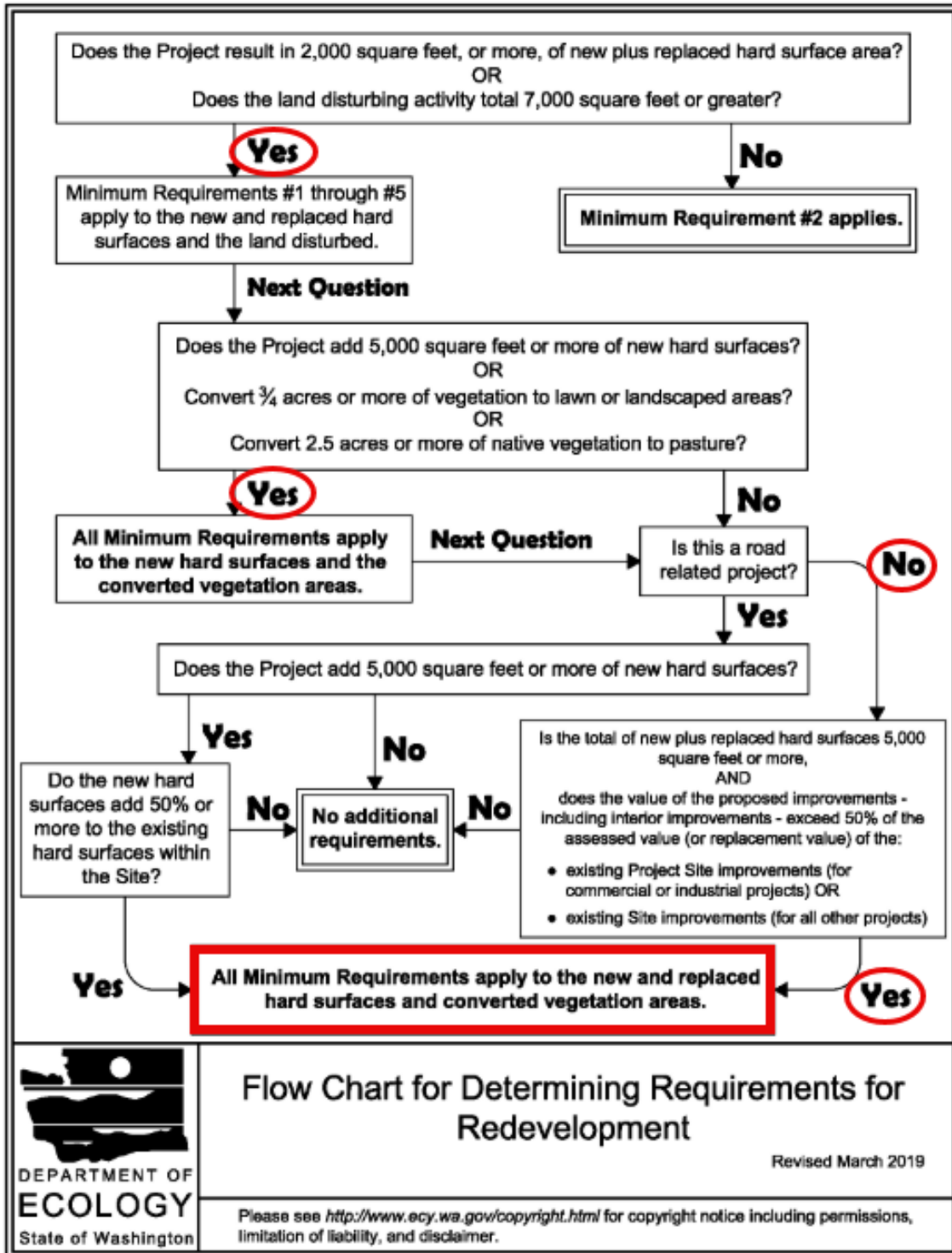

Flow Chart for Determining Requirements for Redevelopment

Revised March 2019

Please see <http://www.ecy.wa.gov/copyright.html> for copyright notice including permissions, limitation of liability, and disclaimer.

Figure 5 – Flow Chart for Determining LID Requirements:

Figure I-3.3: Flow Chart for Determining MR #5 Requirements

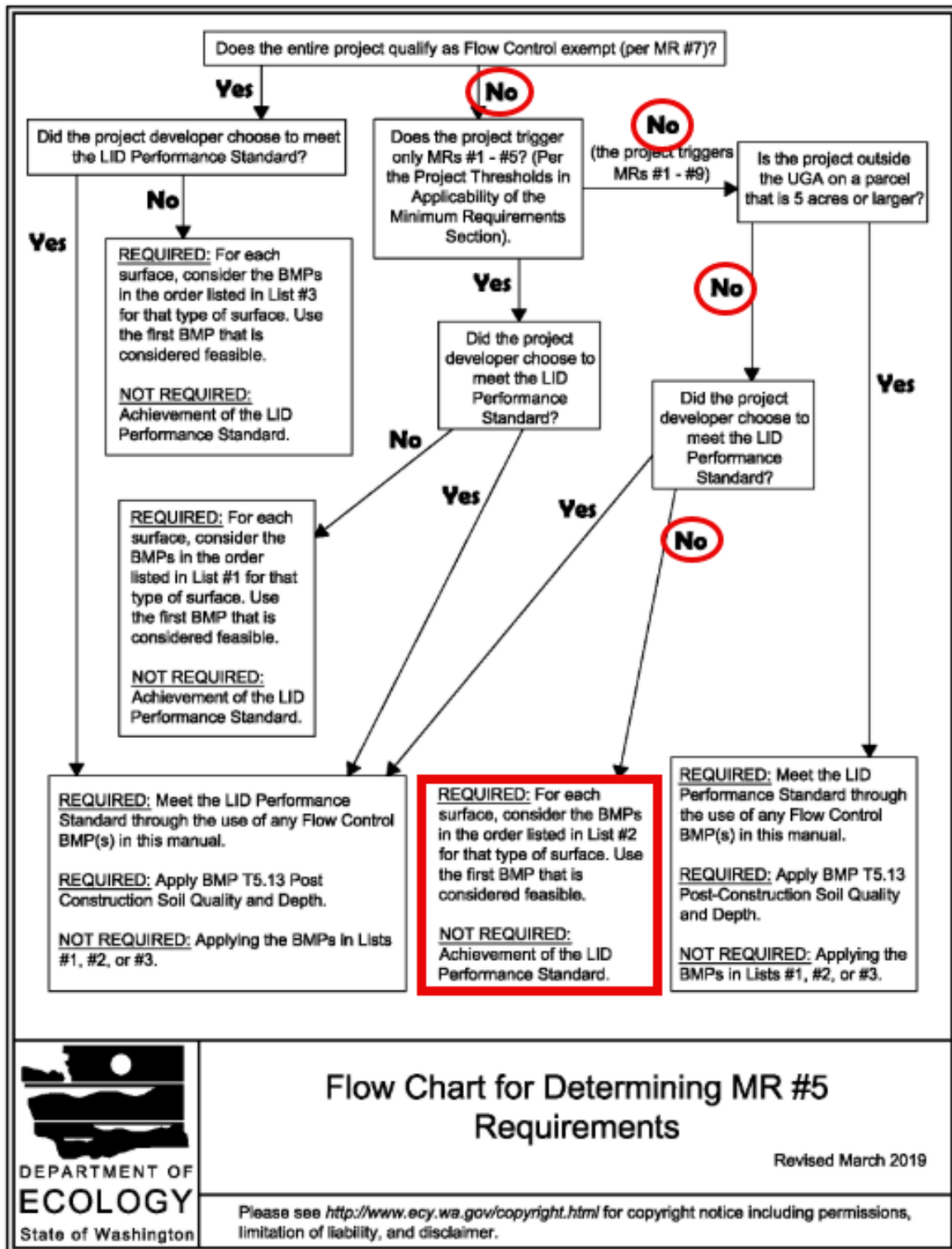

MINIMUM REQUIREMENT #1: Preparation of Storm Water Site Plans

Please refer to *Appendix B* of this report.

MINIMUM REQUIREMENT #2: Construction Storm Water Pollution Prevention Plans

Please refer to *Appendix D* of this report.

MINIMUM REQUIREMENT #3: Source Control of Pollution

None proposed for this project.

MINIMUM REQUIREMENT #4: Preservation of Natural Drainage Systems and Outfalls

Stormwater post-development will mimic existing conditions and will sheet flow towards the western edge of the property.

The proposed direct stub-out connection to the storm system within 72nd Place SE will not change the natural drainage conditions of the site and will not significantly cause adverse impacts to downstream storm systems. See Appendix B1 for an analysis of downstream storm pipe capacity.

MINIMUM REQUIREMENT #5: On-site Storm Water Management

Please refer to *Stormwater Site Plans in Appendix B* to aid in the following description as well as *Section 6* for detailed sizing calculations for the following described storm BMPs.

Per Figure 5, the project triggers minimum requirements #1 through #5; stormwater runoff from the project will be managed by on-site BMPs from **List #1**:

Lawn and landscaped areas:

1. Post-Construction Soil Quality and Depth in accordance with Chapter D5 of 2022 SWES and BMP T5.13 in Chapter 5 of Volume V of the DOE Manual. – **will be met**

Roofs:

1. **Full Dispersion** in accordance with Chapter D5 of the 2022 SWES and BMP T5.30 in Chapter 5 of Volume V of the DOE Manual, or Downspout Full Infiltration Systems in accordance with Chapter D5 of 2022 SWES and BMP T5.10A in Section 3.1.1 in Chapter 3 of Volume III of the DOE Manual. – **not feasible due to inadequate space for flowpath on site.**
2. Bioretention (See Chapter D5 of 2022 SWES and Chapter 7 of Volume V of the DOE Manual) facilities that have a minimum horizontally projected surface area below the overflow which is at least 5% of the total surface area draining to it.

- not feasible due to inadequate area and Geotech recommendation against on-site infiltration.

3. Downspout Dispersion Systems in accordance with Chapter D5 of 2022 SWES and BMP T5.10B in Section 3.1.2 in Chapter 3 of Volume III of the DOE Manual.
- Not feasible due to inadequate area and flowpath constraints. The site generally slopes towards the front yard with inadequate area for dispersion, therefore splashblocks are also infeasible.
4. Perforated Stub-Out Connection in accordance with Chapter D5 of 2020 SWES and BMP T5.10B in Section 3.1.2 in Chapter 3 of Volume III of the DOE Manual.
- Not feasible due Geotech's recommendation against on-site infiltration. See Geotech Report in Appendix C for more details.

Due to the size of the lot and onsite soils that do not support infiltration or dispersion BMPs, as well as insufficient area for dispersion flowpaths, a **direct stub-out connection** to the existing storm system within 72nd Place SE to the west is proposed. Runoff from property will be collected and connected to the existing storm system via an existing catch basin in the southeastern corner of the property.

MINIMUM REQUIREMENT #6: Runoff Treatment

Thresholds for Runoff Treatment:

- Projects in which the total of, PGHS is 5,000 square feet or more, or;
- Projects in which the total of PGPS – not including permeable pavements – is 3/4 of an acre or more, and from which there will be a surface discharge in a natural or man-made conveyance system from the site.

*This project proposes approximately 1,734 sf of pollution-generating hard surfaces (PGHS) on site, and no pollution-generating pervious surfaces (PHPS). **This project does not trigger thresholds for Runoff Treatment. No Water Quality Management BMPs are proposed, and the project will use a direct connection to the existing storm system in the right-of-way. See stormwater site plans in Appendix A for details.***

MINIMUM REQUIREMENT #7: Flow Control

Thresholds for Flow Control:

- Projects in which the total of effective impervious surfaces is 10,000 square feet or more in a threshold discharge area, or
- Projects that convert 3/4 acres or more of vegetation to lawn or landscape or convert 2.5 acres or more of native vegetation to pasture in a threshold discharge area, and from which there is a surface discharge in a natural or man-made conveyance system from the site.

The project will create 7,374 sf of new plus replaced hard surface area, less than the threshold of 10,000 sf requiring flow control. **The project does not trigger thresholds for Flow Control.**

MINIMUM REQUIREMENT #8: Wetlands Protection

Not applicable. There are no wetland areas onsite or known to be within the vicinity of the project site.

MINIMUM REQUIREMENT #9: Operation and Maintenance

An Operations and Maintenance Manual is provided in *Appendix E* of this report.

4. INFILTRATION FEASIBILITY ASSESSMENT AND INFILTRATION BMP DESIGN

According to the Geotech Report prepared by Geotech Consultants, Inc., onsite soil generally consists of gravelly sands with moderate silt content. They state that infiltration of collected runoff is not recommended due to the presence of basements on the project and neighboring properties. See *Geotech Report in Appendix C*.

5. OFF-SITE CAPACITY ANALYSIS

Figure 6 – Downstream Map



Upstream

The site is down slope of several parcels and may receive runoff from the properties. No adverse impacts are anticipated.

Downstream

In the existing condition, surface runoff generally leaves the site to the west. Runoff enters the 72nd Place SE storm system about 40 feet from the property and flows for about 100 feet southward, then turns westward beneath 34th Street for another 215 feet. After that it enters the 72nd Ave SE storm system and is conveyed south for 545 feet, then turns westward again beneath SE Maker Street for 420 feet until reaching the quarter-mile downstream point from the property. Runoff ultimately outfalls into Lake Washington. There are two points of potential downstream capacity constraints within this series, which are modeled and evaluated in detail, along with the entirety of the quarter-mile tributary system, in Appendix B.

6. HYDROLOGIC/HYDRAULIC ANALYSIS

The Geotech Report for the project site (included in Appendix C) states that infiltration is not recommended, and dispersion is not an option due to the grading and layout of the property. A direct pipe connection to the existing storm system within 72nd Place SE is proposed and will connect via an existing catch basin within 72nd Place SE near the SW corner of the property.

Appendix A

Stormwater Site Plan

Apr 24, 2026 3:49:32PM - User Nick Millman
 P:\2025\25113_Yusen Res - Mercer Island\Drawing\SheetSet\25113_C1.0 COVER SHEET AND SITE PLAN.dwg

YUSEN RESIDENCE

SEC 12, T 24 N, R 4 E, W. M.

PROJECT TEAM:

OWNER:
 DAVID AND CAITLIN YUSEN
 8717 SE 44TH PLACE
 MERCER ISLAND, WA 98040
 PH: 425.591.6904

ARCHITECT:
 STURMAN ARCHITECTS
 BRAD STURMAN
 9-103RD AVE NE, SUITE 203
 BELLEVUE, WA 98004
 PH: 425.451.7003
 EMAIL: BRAD@STURMANARCHITECTS.COM

CIVIL ENGINEER:
 PATRICK HARRON & ASSOCIATES, LLC
 SCHWIN CHAOSILAPAKUL, PE
 14900 INTERURBAN AVENUE S #279
 SEATTLE, WA 98168
 PH: 206.674.4659
 EMAIL: SCHWIN@PATRICKHARRON.COM

CONTRACTOR:
 RKK CONSTRUCTION INC
 JASON KOEHLER
 3056 70TH AVE SE
 MERCER ISLAND, WA 98040
 PH: 206.730.1237

SURVEYOR:
 RYKA LAND SERVICES
 RAYMOND E SLATER JR
 7525 SE 24TH ST
 MERCER ISLAND, WA 98040
 PH: 206.523.1941

GEOTECHNICAL ENGINEER:
 GEOTECH CONSULTANTS, INC
 MARC MCGINNIS
 2401 10TH AVE EAST
 SEATTLE, WA 98102
 PH: 425.747.5618
 EMAIL: MARCM@GEOTECHNW.COM

ARBORIST:
 SEATTLE TREE CONSULTING
 JOHN WELLS, DOUGLAS SMITH
 3907 AURORA AVE N
 SEATTLE WA 98103
 PH: 206.457.5706

STRUCTURAL:
 OG ENGINEERING
 OWEN GOULD
 SEATTLE, WA
 PH: 206.290.4608
 EMAIL: OWEN@OGENGINEERING.COM

SITE NOTES:

1. SOILS OF DISTURBED PERVIOUS AREAS TO BE AMENDED.

STORM CALLOUTS:

1. PROPOSED STORM DRAINAGE SYSTEM, TYP (SEE SHEET C3.0 FOR STORMWATER PLAN).

SITE CALLOUTS:

- PROPERTY BOUNDARY, TYP.
- PROPOSED BUILDING FOOTPRINT, TYP.
- PROPOSED BUILDING ROOFLINE, TYP.
- BUILDING SETBACK LINE, TYP. SEE PROJECT INFORMATION FOR MINIMUM SETBACKS.
- EXISTING TREES TO BE PROTECTED-IN-PLACE UNLESS OTHERWISE NOTED, TYP (SEE ARBORIST REPORT AND SHEET C2.0 FOR LIMITS OF DISTURBANCE AND TREE PROTECTION).
- TREE PROTECTION FENCING, TYP (SEE SHEET C2.0).
- PROPOSED ON-SITE CONCRETE DRIVEWAY/PARKING, TYP.

SEWER & WATER CALLOUTS:

- PROPOSED DOMESTIC WATER SERVICE CONNECTED TO EXISTING METER.
- PROPOSED SANITARY SEWER SYSTEM.

PROJECT INFORMATION:

DEVELOPMENT DATA:
 PROPERTY AREA 16,586 SF (0.38 AC)
 SITE ADDRESS 3245 72ND PL SE
 MERCER ISLAND, WA 98040
 PARCEL NUMBER 130030-0840
 ZONED R-8.4
BUILDING SETBACKS:
 FRONT YARD 20.0 FT
 SIDE YARD 15.0 FT, 5FT MIN
 REAR YARD 25.0 FT
 LOT COVERAGE (BLDG) LESSER OF 40% LOT AREA OR 5,000 SF

UTILITIES:
 SEWER MERCER ISLAND PUBLIC WORKS
 WATER WATER DISTRICT
 POWER PUGET SOUND ENERGY
 FIRE DISTRICT MERCER ISLAND FIRE DEPARTMENT

LEGAL DESCRIPTION:

(PER STATUTORY WARRANTY DEED, RECORDING NO. 20250609000850).
 LOTS 23, 24 AND 25, BLOCK 3;
 EXCEPT THE EAST 65 FEET THEREOF;
 AND THE NORTH 90.27 FEET OF THE SOUTH 150.27 FEET OF MAGNOLIA SQUARE "VACATED";
 AND THAT PORTION OF VACATED 73RD AVENUE SOUTHEAST "WEBSTER STREET" ADJOINING;
 ALL IN C.C. CALKINS' FIRST ADDITION TO EAST SEATTLE, ACCORDING TO THE PLAT THEREOF RECORDED IN VOLUME 4 OF PLATS, PAGE 88, IN KING COUNTY, WASHINGTON

DATUM:

VERTICAL DATUM
 WSPCS - NORTH ZONE NAD 83 (2011)
HORIZONTAL DATUM (BASIS OF ELEVATION)
 CONTINUOUSLY OPERATING REFERENCE STATIONS (CORS) SSSH,
 ZSE1 & HAHD

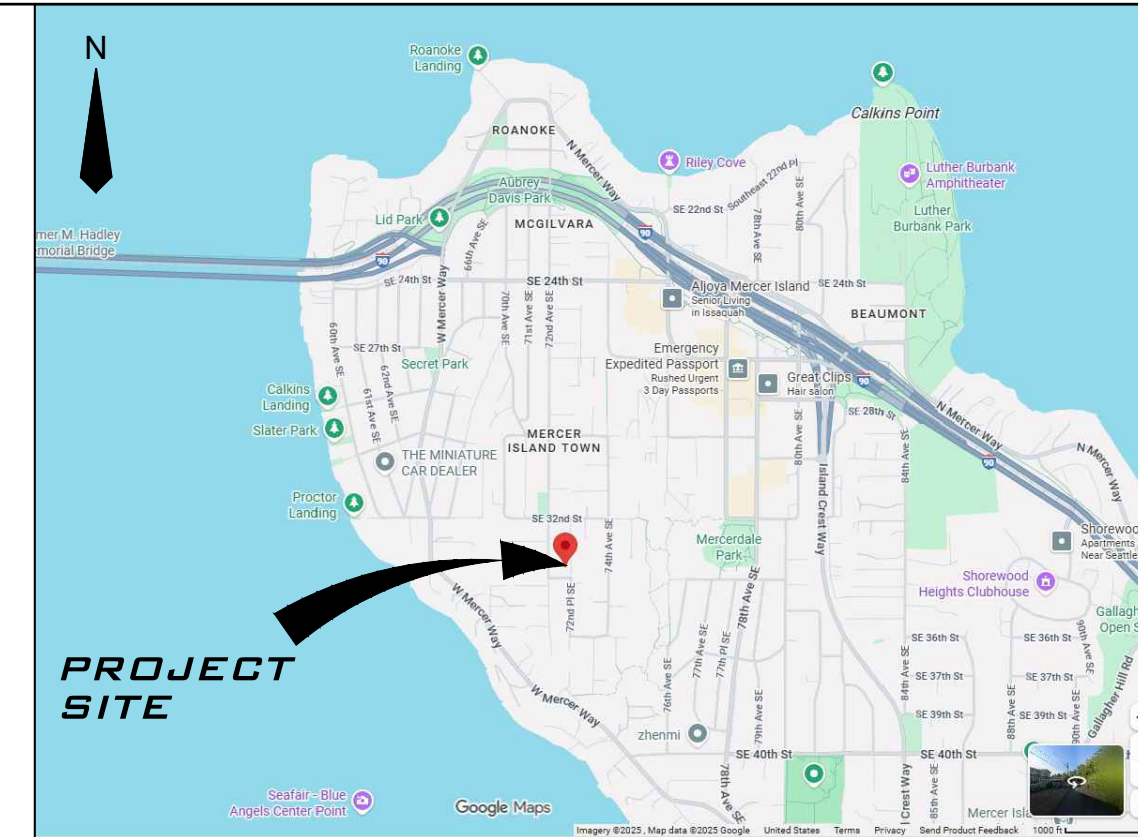

VICINITY MAP
 NTS

ABBREVIATIONS:

AVE	AVENUE
BC	BOTTOM OF CURB
CB	CATCH BASIN
CONC	CONCRETE
CSBC	CRUSHED SURFACE BASE COURSE
CSTC	CRUSHED SURFACE TOP COURSE
DTE	DOWN-TURNED ELBOW
DWS	DESIGN WATER SURFACE
E	EAST
EG	EXISTING GRADE
ELEV	ELEVATION
EX	EXISTING
FD	FOOTING DRAIN
FF	FINISH FLOOR
FG	FINISH GRADE
FL	FLOW LINE
FY	FRONT YARD
HP	HIGH POINT
IE	PIPE INVERT
LP	LOW POINT
N	NORTH
NTS	NOT TO SCALE
R	RADIUS
RD	ROOF DRAIN
RY	REAR YARD
S	SOUTH
SB	BUILDING SETBACK
SDCO	STORM DRAIN CLEANOUT
SDMH	STORM DRAIN MANHOLE
SED	SEDIMENT STORAGE
SF	SQUARE FEET (FOOT)
SS	SANITARY SEWER
SSCO	SANITARY SEWER CLEANOUT
SSMH	SANITARY SEWER MANHOLE
ST	STREET
SLL	SOLID LOCKING LID
SY	SIDE YARD
TC	TOP OF CURB
TD	TRENCH DRAIN
TYP	TYPICAL
UTE	UP-TURNED ELBOW
W	WEST
WA	WATER

SHEET LIST TABLE		
SHEET #	NAME	DESCRIPTION
1	C1.0	COVER SHEET
2	C2.0	TESC PLAN
3	C2.1	TESC DETAILS
4	C3.0	GRADING AND UTILITY PLAN
5	C4.0	STORM PLAN
6	C4.1	STORM DETAILS
7	C5.0	UTILITY PLAN

CALL 48 HOURS BEFORE YOU DIG
 811

THE CONTRACTOR SHALL BE FULLY RESPONSIBLE FOR THE LOCATION AND PROTECTION OF ALL EXISTING UTILITIES. THE CONTRACTOR SHALL VERIFY ALL UTILITY LOCATIONS PRIOR TO CONSTRUCTION BY CALLING THE UNDERGROUND LOCATE LINE AT 1-800-424-5555 OR 811 (CELL) A MINIMUM OF 48 HOURS PRIOR TO ANY EXCAVATION.

R#	DATE	DESCRIPTION	BY
1	4/7/26	RESPONSE TO 1ST CITY COMMENTS DATED 2/24/26	NEM
2	4/24/26	RESPONSE TO 2ND CITY COMMENTS DATED 4/10/26	NEM

CITY OF MERCER ISLAND
COVER SHEET

PATRICK HARRON & ASSOCIATES, LLC
 Civil Engineering & Planning
 14900 Interurban Ave. S, Suite 279, Seattle, WA 98168
 Phone: 206.674.4659
 Web: patrickharron.com







PROJ. NO. 25113	DRN. BY: NM, CMC
DWN. BY: SCHWIN	CHK. BY: SC

YUSEN RESIDENCE
 DATE: 4/24/26
 SCALE: AS SHOWN
 DRAWING NO. C1.0
 1 OF 7

YUSEN RESIDENCE

SEC 12, T 24 N, R 4 E, W. M.

TESC LEGEND:

-  REMOVE TREE
-  CATCH BASIN INLET PROTECTION
-  SAWCUT
-  TEMPORARY SILT FENCE
-  TEMPORARY TREE & VEGETATION PROTECTIVE FENCE
-  CLEARING LIMITS
-  TEMPORARY CONSTRUCTION ENTRANCE

DEMOLITION & TESC CALLOUTS:

1. TEMPORARY CONSTRUCTION ENTRANCE (SEE DETAIL, SHEET C2.1). COORDINATE WITH SITE INSPECTOR FOR LOCATION AND EXTENTS.
2. TEMPORARY SILT FENCE, TYP (SEE DETAIL, SHEET C2.1 AND TESC NOTE 4). ALTERNATIVELY, STRAW WATTLES MAY BE USED TO LESSEN IMPACTS ON TREE ROOT SYSTEMS. IMPLEMENTATION OF SEDIMENT CONTROL SYSTEMS TO BE COORDINATED WITH PROJECT ARBORIST FOR AREAS WITHIN TPZ.
3. CATCH BASIN INLET PROTECTION, TYP (SEE DETAIL, SHEET C2.1).
4. TEMPORARY TREE & VEGETATION PROTECTIVE FENCE, TYP (SEE DETAIL, SHEET C2.1). SEE DEMOLITION & TESC NOTES, THIS SHEET, FOR ADDITIONAL TREE PROTECTION GUIDELINES.
5. SOILS OF DISTURBED PERVIOUS AREAS ARE TO BE AMENDED, PER BMP 15.13, TYP (SEE DETAIL, SHEET C3.1).

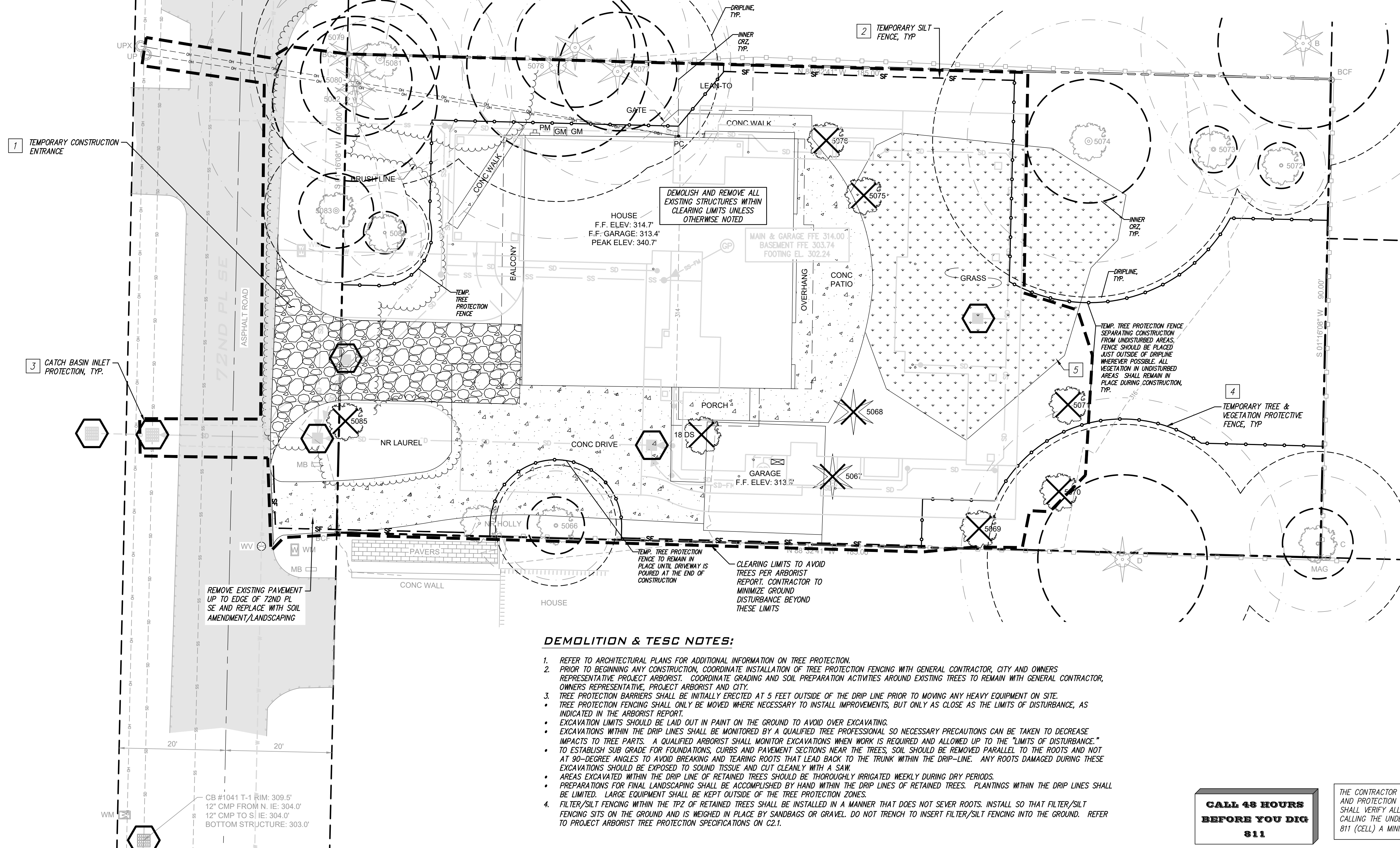
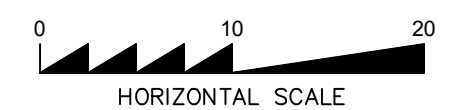
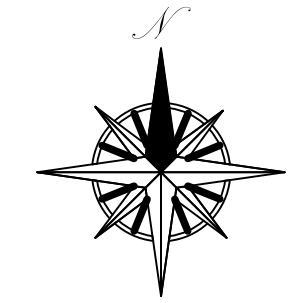

DEMOLITION & TESC NOTES:

1. REFER TO ARCHITECTURAL PLANS FOR ADDITIONAL INFORMATION ON TREE PROTECTION.
2. PRIOR TO BEGINNING ANY CONSTRUCTION, COORDINATE INSTALLATION OF TREE PROTECTION FENCING WITH GENERAL CONTRACTOR, CITY AND OWNERS REPRESENTATIVE, PROJECT ARBORIST. COORDINATE GRADING AND SOIL PREPARATION ACTIVITIES AROUND EXISTING TREES TO REMAIN WITH GENERAL CONTRACTOR, OWNERS REPRESENTATIVE, PROJECT ARBORIST AND CITY.
3. TREE PROTECTION BARRIERS SHALL BE INITIALLY ERECTED AT 5 FEET OUTSIDE OF THE DRIP LINE PRIOR TO MOVING ANY HEAVY EQUIPMENT ON SITE. TREE PROTECTION FENCING SHALL ONLY BE MOVED WHERE NECESSARY TO INSTALL IMPROVEMENTS, BUT ONLY AS CLOSE AS THE LIMITS OF DISTURBANCE, AS INDICATED IN THE ARBORIST REPORT.
 - EXCAVATION LIMITS SHOULD BE LAID OUT IN PAINT ON THE GROUND TO AVOID OVER EXCAVATING.
 - EXCAVATIONS WITHIN THE DRIP LINES SHALL BE MONITORED BY A QUALIFIED TREE PROFESSIONAL SO NECESSARY PRECAUTIONS CAN BE TAKEN TO DECREASE IMPACTS TO TREE PARTS. A QUALIFIED ARBORIST SHALL MONITOR EXCAVATIONS WHEN WORK IS REQUIRED AND ALLOWED UP TO THE "LIMITS OF DISTURBANCE."
 - TO ESTABLISH SUB GRADE FOR FOUNDATIONS, CURBS AND PAVEMENT SECTIONS NEAR THE TREES, SOIL SHOULD BE REMOVED PARALLEL TO THE ROOTS AND NOT AT 90-DEGREE ANGLES TO AVOID BREAKING AND TEARING ROOTS THAT LEAD BACK TO THE TRUNK WITHIN THE DRIP-LINE. ANY ROOTS DAMAGED DURING THESE EXCAVATIONS SHOULD BE EXPOSED TO SOUND TISSUE AND CUT CLEANLY WITH A SAW.
 - AREAS EXCAVATED WITHIN THE DRIP LINE OF RETAINED TREES SHOULD BE THOROUGHLY IRRIGATED WEEKLY DURING DRY PERIODS.
 - PREPARATIONS FOR FINAL LANDSCAPING SHALL BE ACCOMPLISHED BY HAND WITHIN THE DRIP LINES OF RETAINED TREES. PLANTINGS WITHIN THE DRIP LINES SHALL BE LIMITED. LARGE EQUIPMENT SHALL BE KEPT OUTSIDE OF THE TREE PROTECTION ZONES.
4. FILTER/SILT FENCING WITHIN THE TPZ OF RETAINED TREES SHALL BE INSTALLED IN A MANNER THAT DOES NOT SEVER ROOTS. INSTALL SO THAT FILTER/SILT FENCING SITS ON THE GROUND AND IS WEIGHED IN PLACE BY SANDBAGS OR GRAVEL. DO NOT TRENCH TO INSERT FILTER/SILT FENCING INTO THE GROUND. REFER TO PROJECT ARBORIST TREE PROTECTION SPECIFICATIONS ON C2.1.

CALL 48 HOURS BEFORE YOU DIG
811

THE CONTRACTOR SHALL BE FULLY RESPONSIBLE FOR THE LOCATION AND PROTECTION OF ALL EXISTING UTILITIES. THE CONTRACTOR SHALL VERIFY ALL UTILITY LOCATIONS PRIOR TO CONSTRUCTION BY CALLING THE UNDERGROUND LOCATE LINE AT 1-800-424-5555 OR 811 (CELL) A MINIMUM OF 48 HOURS PRIOR TO ANY EXCAVATION.

BY	DESCRIPTION	DATE	R#
	RESPONSE TO 1ST CITY COMMENTS DATED 2/24/26	4/7/26	1
	RESPONSE TO 2ND CITY COMMENTS DATED 4/10/26	4/24/26	2
			3
			4
			5
			6
			7
			8
			9
			10
			11
			12
			13
			14
			15
			16
			17
			18
			19
			20
			21
			22
			23
			24
			25
			26
			27
			28
			29
			30
			31
			32
			33
			34
			35
			36
			37
			38
			39
			40
			41
			42
			43
			44
			45
			46
			47
			48
			49
			50
			51
			52
			53
			54
			55
			56
			57
			58
			59
			60
			61
			62
			63
			64
			65
			66
			67
			68
			69
			70
			71
			72
			73
			74
			75
			76
			77
			78
			79
			80
			81
			82
			83
			84
			85
			86
			87
			88
			89
			90
			91
			92
			93
			94
			95
			96
			97
			98
			99
			100

CITY OF MERCER ISLAND

TESC PLAN



PROJ. NO.: 25113
 DRN. BY: NM, CMC
 DWL. BY: SCB#M
 CHL. BY: SC

YUSEN RESIDENCE

DATE: 4/24/26
 SCALE: AS SHOWN
 DRAWING NO.: C2.0
 2 OF 7

CB #1041 T-1 RIM: 309.5'
 12" CMP FROM N. I.E: 304.0'
 12" CMP TO S. I.E: 304.0'
 BOTTOM STRUCTURE: 303.0'

YUSEN RESIDENCE

SEC 12, T 24 N, R 4 E, W. M.

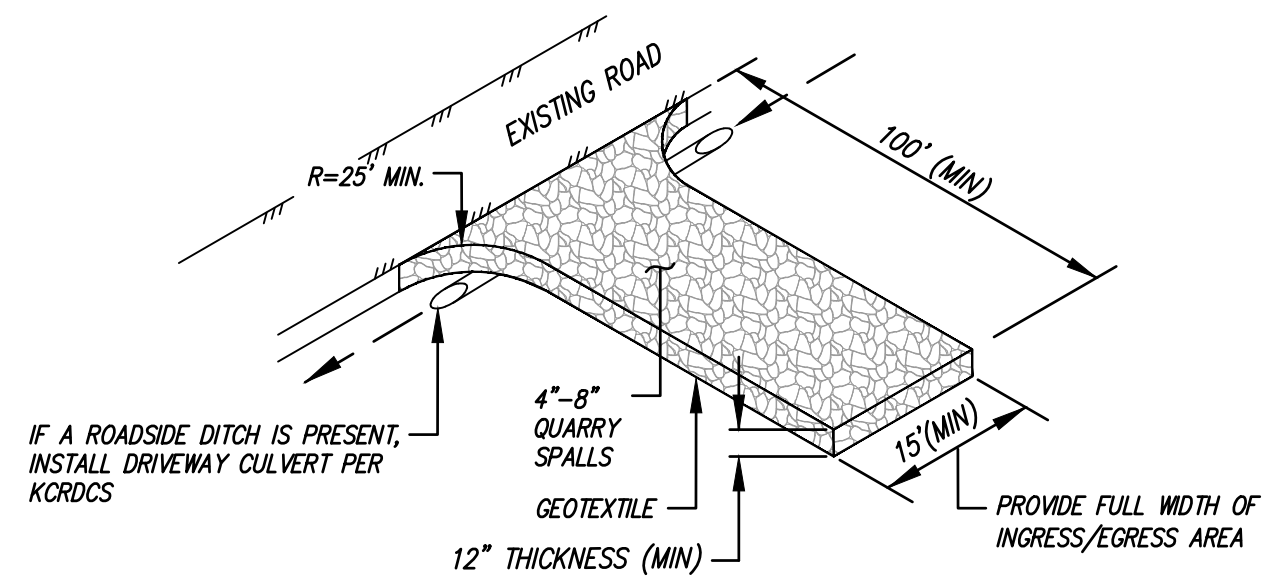

NOTES:

- PER KING COUNTY ROAD DESIGN AND CONSTRUCTION STANDARDS (KCRDCS), DRIVEWAYS SHALL BE PAVED TO EDGE OF R-O-W PRIOR TO INSTALLATION OF THE CONSTRUCTION ENTRANCE TO AVOID DAMAGING OF THE ROADWAY.
- IT IS RECOMMENDED THAT THE ENTRANCE BE CROWNED SO THAT RUNOFF DRAINS OFF THE PAD.

CONSTRUCTION ENTRANCE

SCALE: NTS

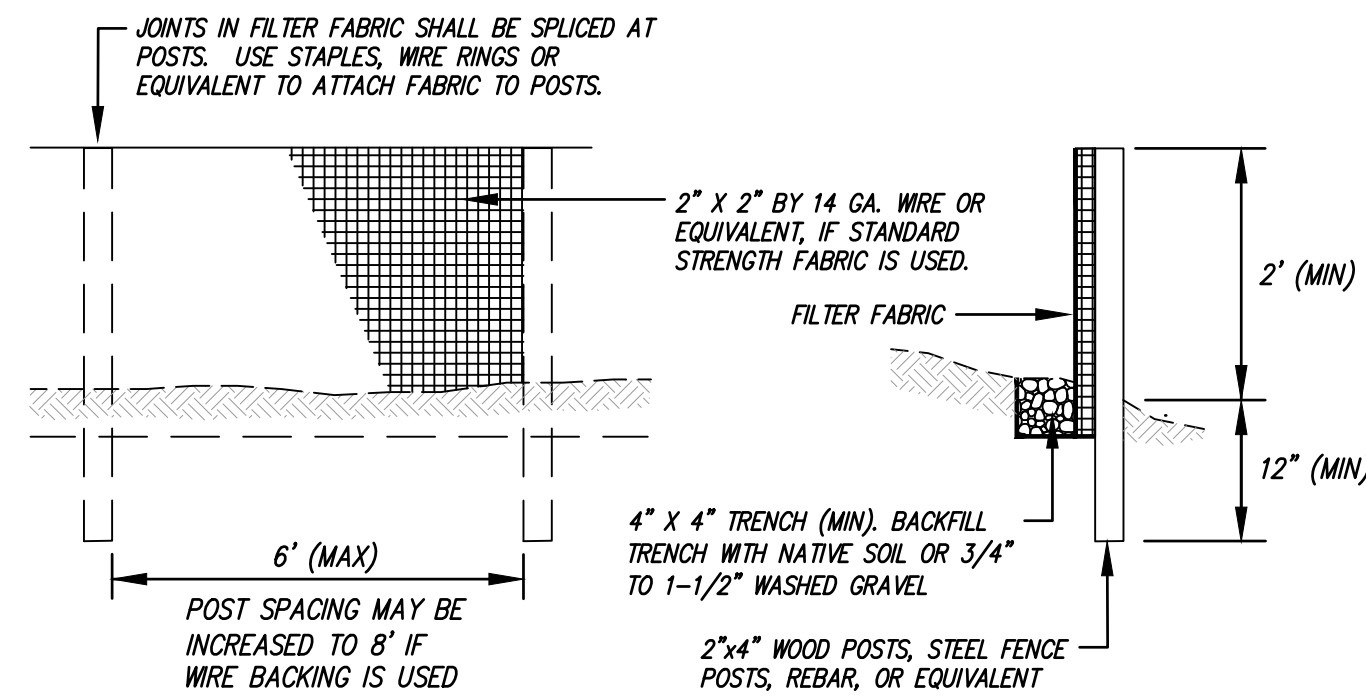

NOTE:

- SILT FILTER FABRIC FENCES SHALL BE INSTALLED ALONG CONTOURS WHENEVER POSSIBLE

SILT FENCE

SCALE: NTS

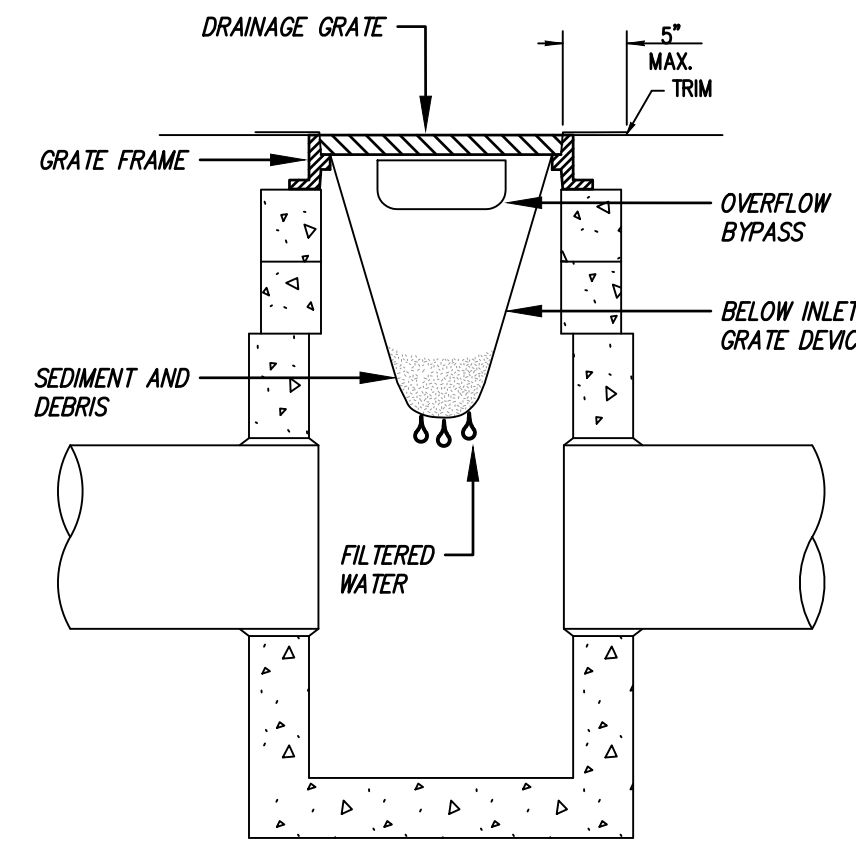

NOTES:

- SIZE THE BELOW INLET GRATE DEVICE (BIGD) FOR THE STORM WATER STRUCTURE IT WILL SERVICE.
- THE BIGD SHALL HAVE A BUILT-IN HIGH-FLOW RELIEF SYSTEM (OVERFLOW BYPASS).
- THE RETRIEVAL SYSTEM MUST ALLOW REMOVAL OF THE BIGD WITHOUT SPILLING THE COLLECTED MATERIAL.
- PERFORM MAINTENANCE IN ACCORDANCE WITH WSDOT STANDARD SPECIFICATION 8-01.3(15).

CATCH BASIN INLET PROTECTION

SCALE: NTS

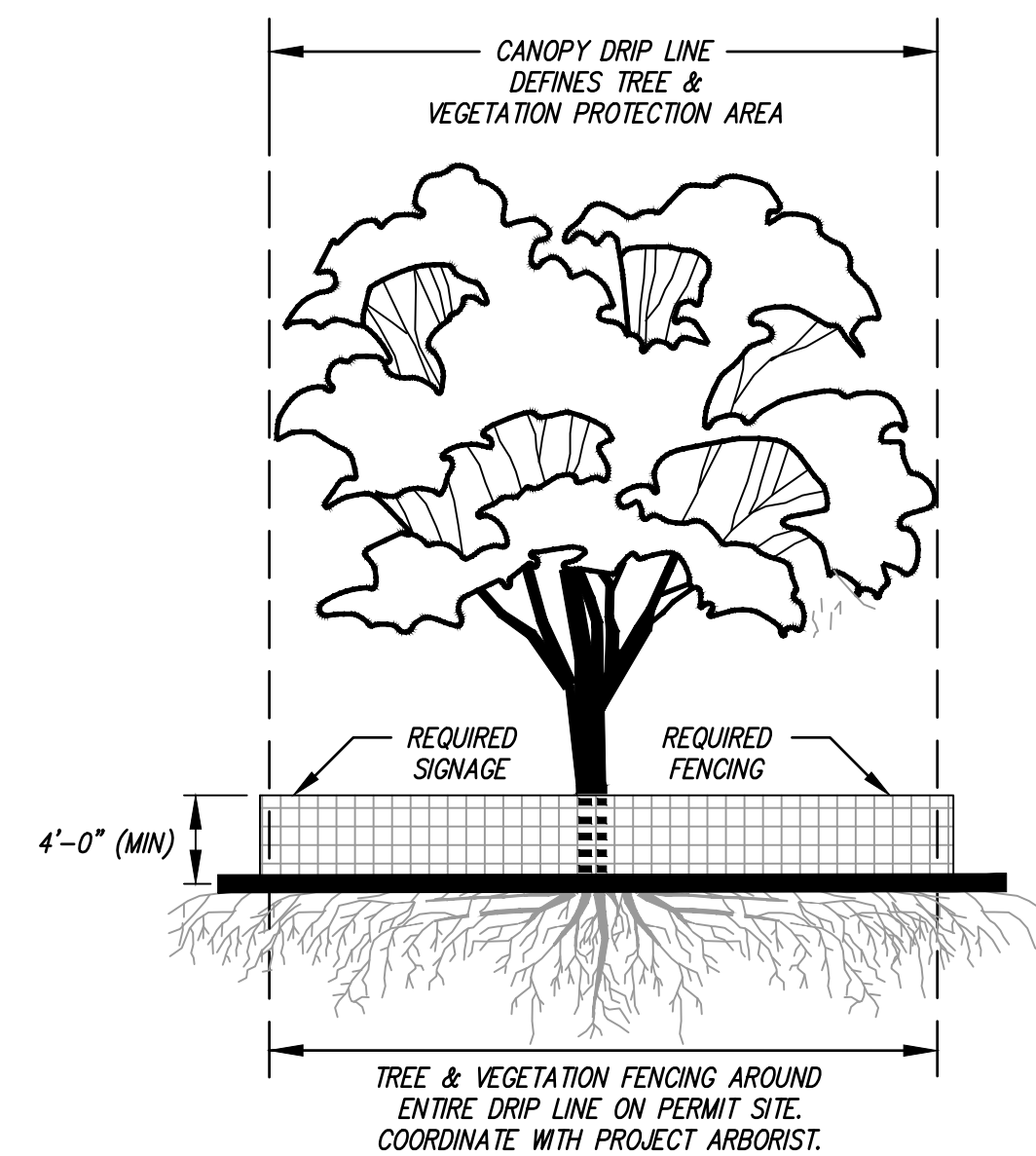
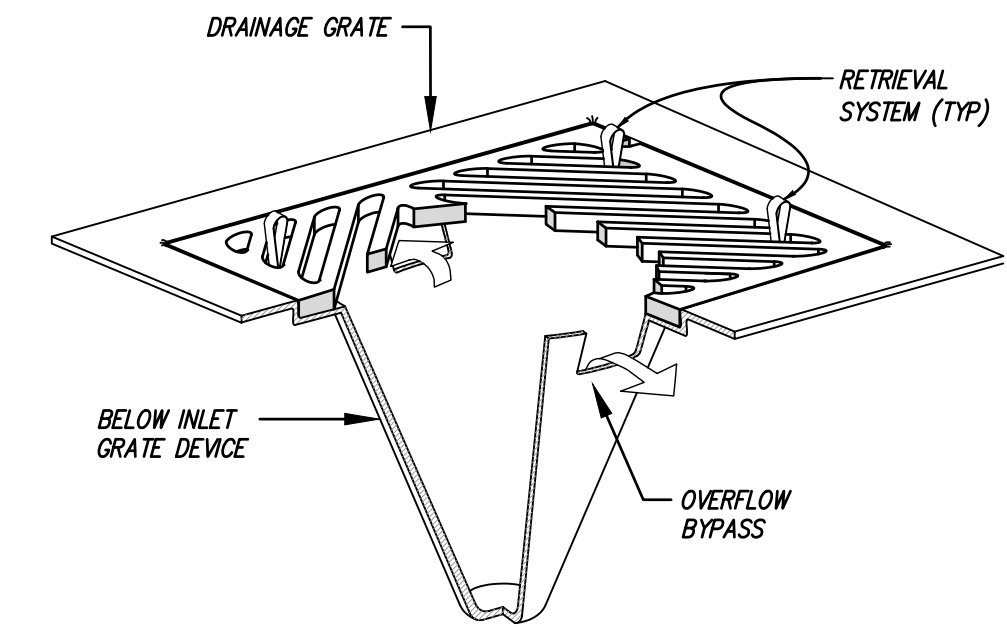

TREE PROTECTION FENCING AND SIGN

- CHAIN LINK, WIRE MESH, OR SIMILAR OPEN RIGID MATERIAL (NO PLYWOOD)
- MUST BE INSTALLED PRIOR TO DEMOLITION OR GROUND DISTURBANCE
- KEPT IN PLACE FOR THE DURATION OF CONSTRUCTION
- NO SOIL DISTURBANCE OR ACTIVITY ALLOWED WITHIN FENCED AREA: MATERIAL STORAGE/STOCKPILING, PARKING, EXCAVATION, DUMPING, OR WASHING
- MODIFICATIONS OF THESE REQUIREMENTS BY APPROVAL OF SDCI PLANNER ONLY
- IF ROOTS GREATER THAN 2 INCH FOUND OUTSIDE OF FENCING, PROTECT BY HAND EXCAVATION AND, IF NECESSARY, CUT CLEANLY AND KEEP MOIST
- USE 3 INCHES OR DEEPER WOOD CHIP MULCH OUTSIDE FENCED AREAS TO PROTECT FEEDER ROOTS

VEGETATION PROTECTION

- ORANGE MESH OR SIMILAR OPEN MATERIAL
- MINIMIZE CONSTRUCTION ZONE
- PROTECT VEGETATION OUTSIDE CONSTRUCTION ZONE WITH FENCING AS SHOWN
- USE 3 INCHES OR DEEPER WOOD CHIP MULCH OUTSIDE FENCED AREAS TO PROTECT FEEDER ROOTS

TREE & VEGETATION PROTECTIVE FENCE

SCALE: NTS

BY	DESCRIPTION	DATE	R#

CITY OF MERCER ISLAND

TESC DETAILS

PATRICK HARRON & ASSOCIATES, LLC
Civil Engineering & Planning
14800 Interurban Ave. S, Suite 279, Seattle, WA 98148
Phone: 206.674.4669
Web: patrickharron.com

PROJ. NO.: 25113	DRN. BY: NM, CMC
DRAWN BY: SCS/HHM	CHEK. BY: SC

YUSEN RESIDENCE

DAVID & CAITLIN YUSEN
3246 72ND PL. SE
MERCER ISLAND, WA 98040

DATE: 4/24/26
SCALE: AS SHOWN
DRAWING NO. C2.1
3 OF 7

CALL 48 HOURS BEFORE YOU DIG 811

THE CONTRACTOR SHALL BE FULLY RESPONSIBLE FOR THE LOCATION AND PROTECTION OF ALL EXISTING UTILITIES. THE CONTRACTOR SHALL VERIFY ALL UTILITY LOCATIONS PRIOR TO CONSTRUCTION BY CALLING THE UNDERGROUND LOCATE LINE AT 1-800-424-5555 OR 811 (CELL) A MINIMUM OF 48 HOURS PRIOR TO ANY EXCAVATION.

Apr 24, 2026 3:49:45PM - User Nick Millman
P: \2025\25113_Yusen Res - Mercer Island\Working\SheetSet\25113_C2.1_TESC_DETAIL.dwg

YUSEN RESIDENCE

SECTION 05110 - 01.00 - 01

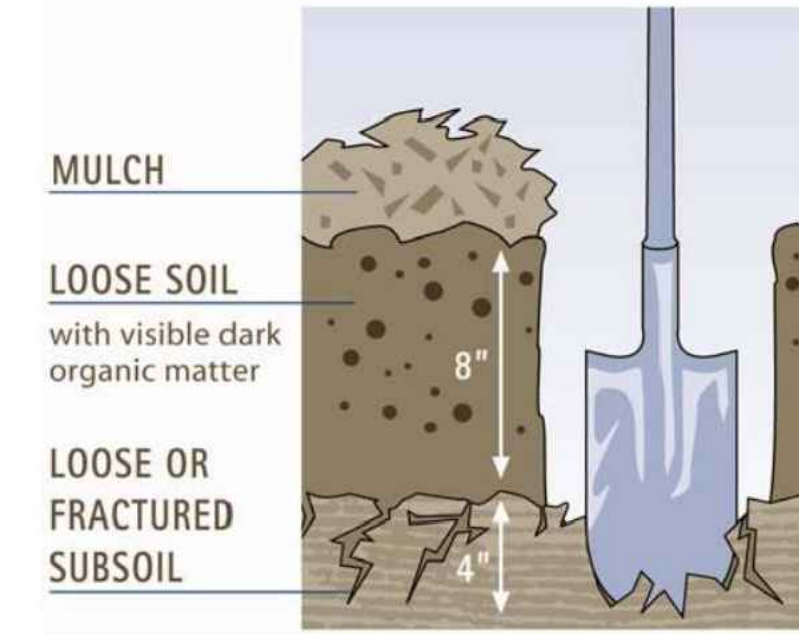
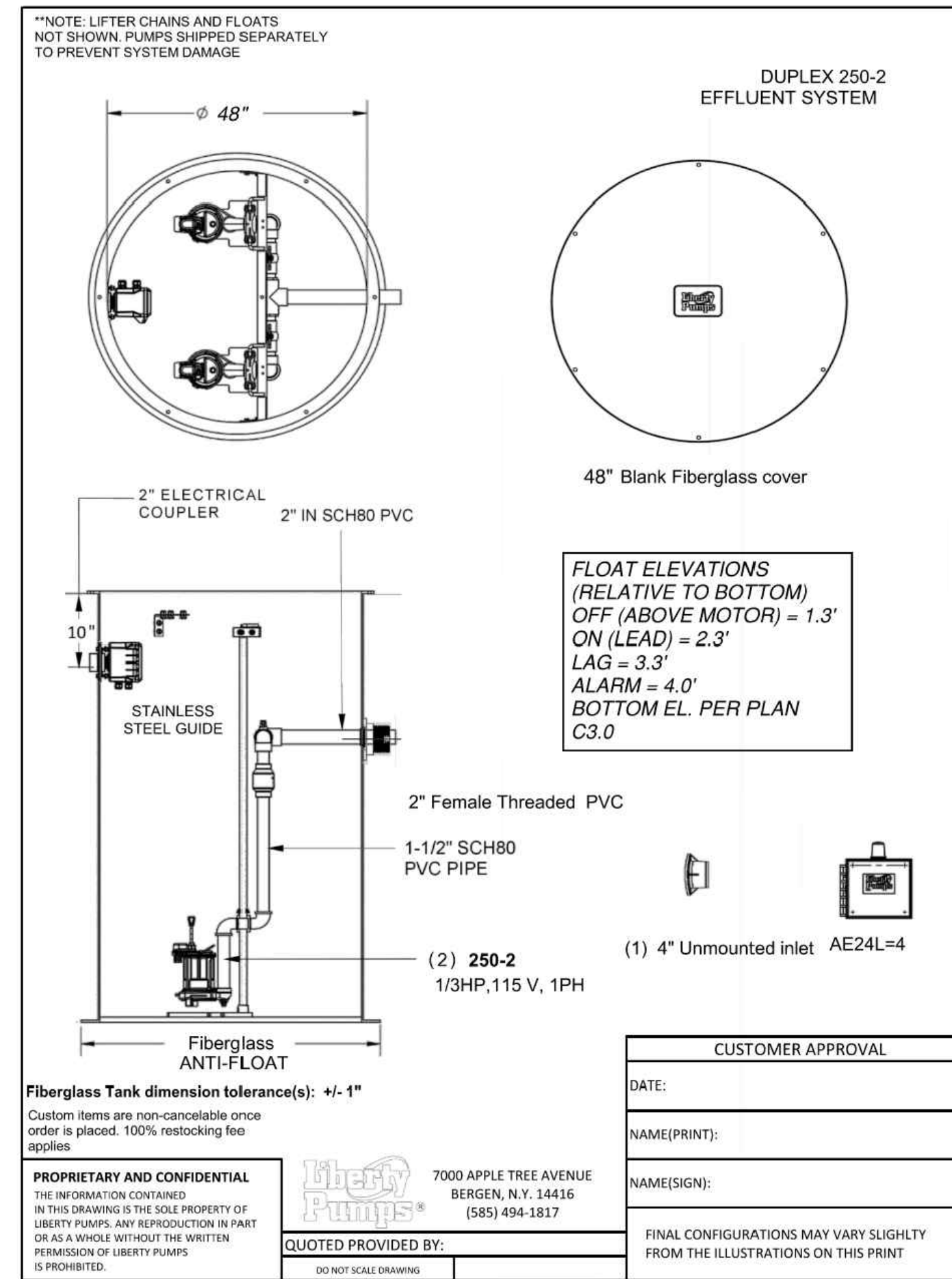
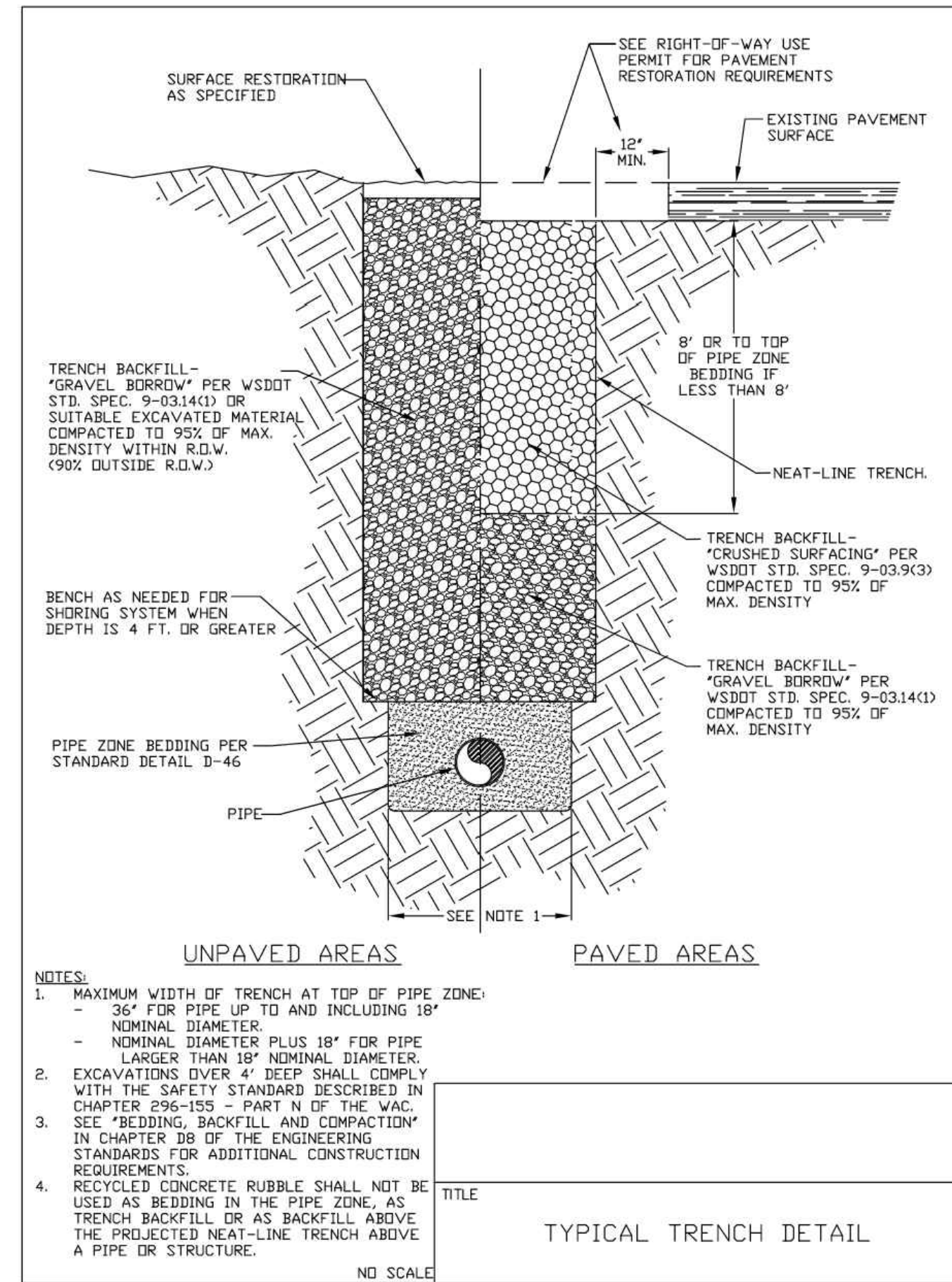
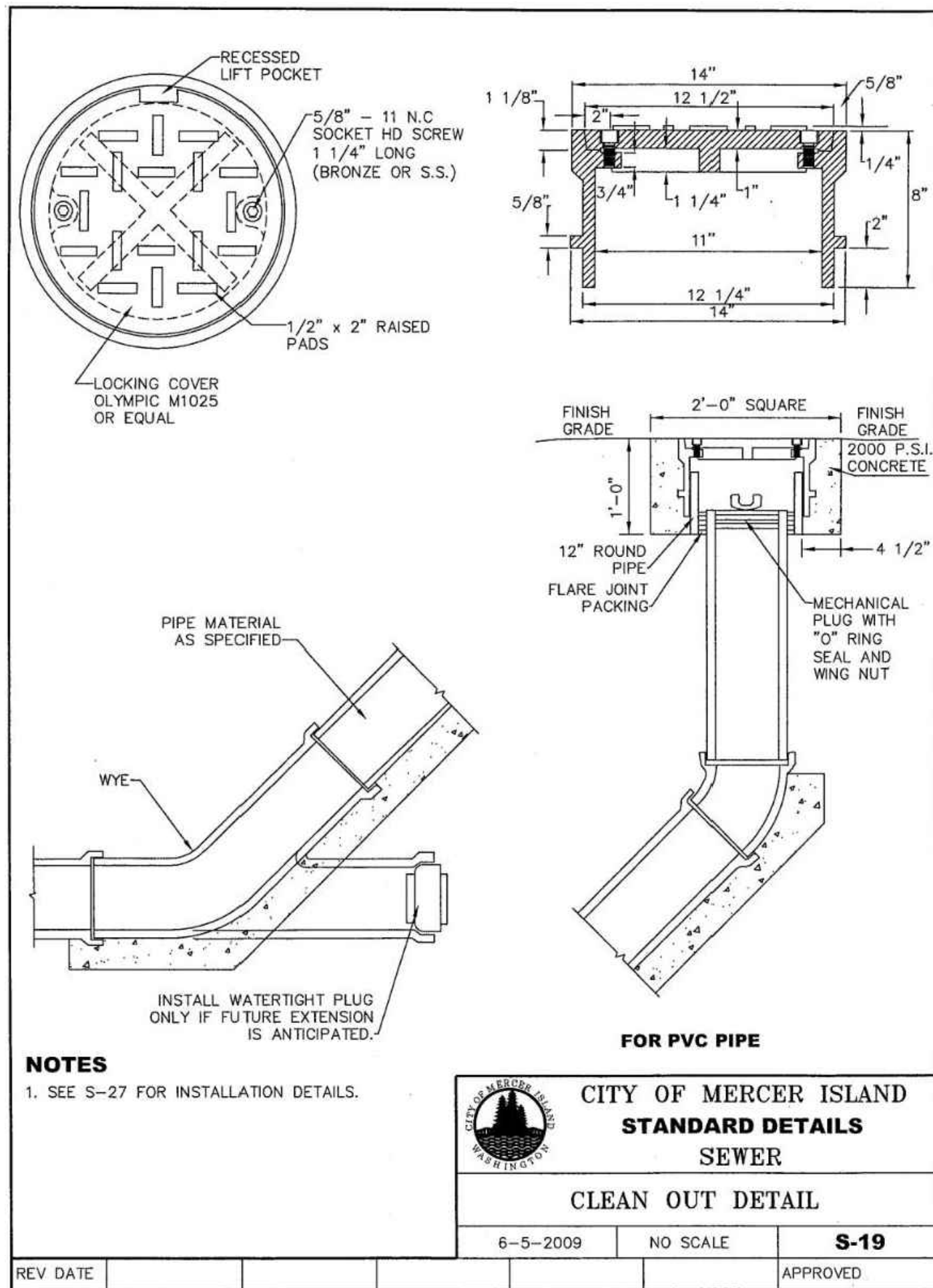

DESIGN GUIDELINES:

- SOIL RETENTION. RETAIN, IN AN UNDISTURBED STATE, THE DUFF LAYER AND NATIVE TOPSOIL TO THE MAXIMUM EXTENT PRACTICABLE. IN ANY AREAS REQUIRING GRADING REMOVE AND STOCKPILE THE DUFF LAYER AND TOPSOIL ON SITE IN A DESIGNATED, CONTROLLED AREA, NOT ADJACENT TO PUBLIC RESOURCES AND CRITICAL AREAS, TO BE REAPPLIED TO OTHER PORTIONS OF THE SITE WHERE FEASIBLE.
- SOIL QUALITY. ALL AREAS SUBJECT TO CLEARING AND GRADING THAT HAVE NOT BEEN COVERED BY IMPERVIOUS SURFACE, INCORPORATED INTO A DRAINAGE FACILITY OR ENGINEERED AS STRUCTURAL FILL OR SLOPE SHALL, AT PROJECT COMPLETION, DEMONSTRATE THE FOLLOWING:
 - A TOPSOIL LAYER WITH A MINIMUM ORGANIC MATTER CONTENT OF 10% DRY WEIGHT IN PLANTING BEDS, AND 5% ORGANIC MATTER CONTENT IN TURF AREAS, AND A PH FROM 6.0 TO 8.0 OR MATCHING THE PH OF THE UNDISTURBED SOIL. THE TOPSOIL LAYER SHALL HAVE A MINIMUM DEPTH OF EIGHT INCHES EXCEPT WHERE TREE ROOTS LIMIT THE DEPTH OF INCORPORATION OF AMENDMENTS NEEDED TO MEET THE CRITERIA. SUBSOILS BELOW THE TOPSOIL LAYER SHOULD BE SCARIFIED AT LEAST 4 INCHES WITH SOME INCORPORATION OF THE UPPER MATERIAL TO AVOID STRATIFIED LAYERS, WHERE FEASIBLE.
 - MULCH PLANTING BEDS WITH 2 INCHES OF ORGANIC MATERIAL.
 - USE COMPOST AND OTHER MATERIALS THAT MEET THESE ORGANIC CONTENT REQUIREMENTS:
 - THE ORGANIC CONTENT FOR "PRE-APPROVED" AMENDMENT RATES CAN BE MET ONLY USING COMPOST MEETING THE COMPOST SPECIFICATION FOR BIORETENTION (BMP 17.30), WITH THE EXCEPTION THAT THE COMPOST MAY HAVE UP TO 35% BIOSOLIDS OR MANURE. THE COMPOST MUST ALSO HAVE AN ORGANIC MATTER CONTENT OF 40% TO 65%, AND A CARBON TO NITROGEN RATIO BELOW 25:1. THE CARBON TO NITROGEN RATIO MAY BE AS HIGH AS 35:1 FOR PLANTINGS COMPOSED ENTIRELY OF PLANTS NATIVE TO THE PUGET SOUND LOWLANDS REGION.
 - CALCULATED AMENDMENT RATES MAY BE MET THROUGH USE OF COMPOSTED MATERIAL MEETING (A.) ABOVE; OR OTHER ORGANIC MATERIALS AMENDED TO MEET THE CARBON TO NITROGEN RATIO REQUIREMENTS, AND NOT EXCEEDING THE CONTAMINANT LIMITS IDENTIFIED IN TABLE 220-B, TESTING PARAMETERS, IN WAC 173-350-220.

- THE RESULTING SOIL SHOULD BE CONDUCTIVE TO THE TYPE OF VEGETATION TO BE ESTABLISHED.
- IMPLEMENTATION OPTIONS: THE SOIL QUALITY DESIGN GUIDELINES LISTED ABOVE CAN BE MET BY USING ONE OF THE METHODS LISTED BELOW:
 - LEAVE UNDISTURBED NATIVE VEGETATION AND SOIL, AND PROTECT FROM COMPACTION DURING CONSTRUCTION.
 - AMEND EXISTING SITE TOPSOIL OR SUBSOIL EITHER AT DEFAULT "PRE-APPROVED" RATES, OR AT CUSTOM CALCULATED RATES BASED ON TESTS OF THE SOIL AND AMENDMENT.
 - STOCKPILE EXISTING TOPSOIL DURING GRADING, AND REPLACE IT PRIOR TO PLANTING. STOCKPILED TOPSOIL MUST ALSO BE AMENDED IF NEEDED TO MEET THE ORGANIC MATTER OR DEPTH REQUIREMENTS, EITHER AT A DEFAULT "PRE-APPROVED" RATE OR AT A CUSTOM CALCULATED RATE.
 - IMPORT TOPSOIL MIX OF SUFFICIENT ORGANIC CONTENT AND DEPTH TO MEET THE REQUIREMENTS. MORE THAN ONE METHOD MAY BE USED ON DIFFERENT PORTIONS OF THE SAME SITE. SOIL THAT ALREADY MEETS THE DEPTH AND ORGANIC MATTER QUALITY STANDARDS, AND IS NOT COMPACTED, DOES NOT NEED TO BE AMENDED.

MAINTENANCE:

- ESTABLISH SOIL QUALITY AND DEPTH TOWARD THE END OF CONSTRUCTION AND ONCE ESTABLISHED, PROTECT FROM COMPACTION, SUCH AS FROM LARGE MACHINERY USE, AND FROM EROSION.
- PLANT VEGETATION AND MULCH THE AMENDED SOIL AREA AFTER INSTALLATION.
- LEAVE PLANT DEBRIS OR ITS EQUIVALENT ON THE SOIL SURFACE TO REPLENISH ORGANIC MATTER.
- REDUCE AND ADJUST, WHERE POSSIBLE, THE USE OF IRRIGATION, FERTILIZERS, HERBICIDES AND PESTICIDES, RATHER THAN CONTINUING TO IMPLEMENT FORMERLY ESTABLISHED PRACTICES.

CALL 48 HOURS BEFORE YOU DIG
811

THE CONTRACTOR SHALL BE FULLY RESPONSIBLE FOR THE LOCATION AND PROTECTION OF ALL EXISTING UTILITIES. THE CONTRACTOR SHALL VERIFY ALL UTILITY LOCATIONS PRIOR TO CONSTRUCTION BY CALLING THE UNDERGROUND LOCATE LINE AT 1-800-424-5555 OR 811 (CELL) A MINIMUM OF 48 HOURS PRIOR TO ANY EXCAVATION.

PIPE ALLOWANCES

PIPE MATERIAL	MAXIMUM INSIDE DIAMETER (INCHES)
REINFORCED OR PLAIN CONCRETE	12"
ALL METAL PIPE	15"
CPSP (STD. SPEC. SECT. 9-05.20)	12"
SOLID WALL PVC (STD. SPEC. SECT. 9-05.12(1))	15"
PROFILE WALL PVC (STD. SPEC. SECT. 9-05.12(2))	15"

* CORRUGATED POLYETHYLENE STORM SEWER PIPE

- NOTES**
- As acceptable alternatives to the rebar shown in the PRECAST BASE SECTION, fibers (placed according to the Standard Specifications), or wire mesh having a minimum area of 0.12 square inches per foot shall be used with the minimum required rebar shown in the ALTERNATIVE PRECAST BASE SECTION. Wire mesh shall not be placed in the knockouts.
 - The knockout diameter shall not be greater than 20" (in). Knockouts shall have a wall thickness of 2" (in) minimum to 2.5" (in) maximum. Provide a 1.5" (in) minimum gap between the knockout wall and the outside of the pipe. After the pipe is installed, fill the gap with joint mortar in accordance with Standard Specification Section 9-04.3.
 - The maximum depth from the finished grade to the lowest pipe invert shall be 3' (ft).
 - The frame and grate may be installed with the flange down, or integrally cast into the adjustment section with flange up.
 - The Precast Base Section may have a rounded floor, and the walls may be sloped at a rate of 1:24 or steeper.
 - The opening shall be measured at the top of the Precast Base Section.
 - All pickup holes shall be grouted full after the basin has been placed.

CATCH BASIN TYPE 1
STANDARD PLAN B-5.20-03
SHEET 1 OF 1 SHEET

APPROVED FOR PUBLICATION
Roark, Steve
Washington State Department of Transportation

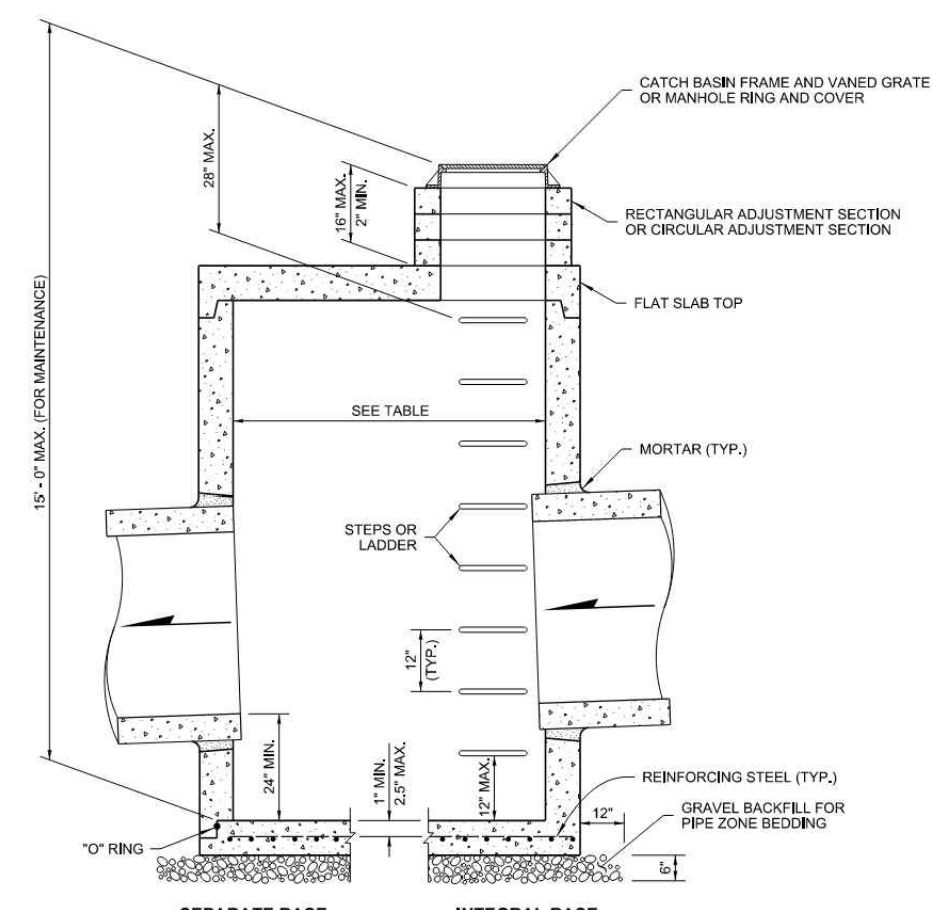

CATCH BASIN DIMENSIONS

CATCH BASIN DIAMETER	MIN. WALL THICKNESS	MIN. BASE THICKNESS	MAXIMUM KNOCKOUT SIZE	MINIMUM DISTANCE BETWEEN KNOCKOUTS
48"	4"	5"	36"	8"
54"	4.5"	5"	42"	8"
60"	5"	6"	48"	8"
72"	6"	6"	60"	12"
84"	8"	12"	72"	12"
96"	8"	12"	84"	12"
120"	10"	12"	96"	12"
144"	12"	12"	108"	12"

PIPE ALLOWANCES

CATCH BASIN DIAMETER	CONCRETE	METAL	CPSP (1)	SOLID WALL PVC (2)	PROFILE WALL PVC (3)
48"	24"	30"	24"	30"	30"
54"	30"	36"	30"	36"	36"
60"	36"	42"	36"	42"	42"
72"	42"	54"	42"	48"	48"
84"	54"	60"	54"	48"	48"
96"	60"	72"	60"	48"	48"
120"	66"	84"	60"	48"	48"
144"	78"	96"	60"	48"	48"

- Corrugated Polyethylene Storm Sewer Pipe (See Standard Specification Section 9-05.20)
- See Standard Specification Section 9-05.12(1)
- See Standard Specification Section 9-05.12(2)
- Polypropylene Pipe (See Standard Specification Section 9-05.24)

CATCH BASIN TYPE 2
STANDARD PLAN B-10.20-02
SHEET 1 OF 1 SHEET

APPROVED FOR PUBLICATION
Heitman, Julie
Washington State Department of Transportation

Apr 24, 2026 3:50:00PM - User Nick Millman
P:\2025\25113_Yusen Res - Mercer Island\Drawing\SheetSet\25113_C4.1_STORM DETAIL.dwg

BY	DESCRIPTION	DATE	R#
MEM	RESPONSE TO 1ST CITY COMMENTS DATED 2/24/26	4/7/26	1
MEM	RESPONSE TO 2ND CITY COMMENTS DATED 4/10/26	4/24/26	2

CITY OF MERCER ISLAND

STORM DETAILS

DAVID & CAITLIN YUSEN
3246 72ND PL SE
MERCER ISLAND, WA 98040

PATRICK HARRON & ASSOCIATES, LLC
Civil Engineering & Planning
14900 Interurban Ave. S, Suite 279, Seattle, WA 98168
Phone: 206.674.4659
Web: patrickharron.com

PROJ. NO.: 25113
CON. BY: SC#11M

DATE: 4/24/26
SCALE: AS SHOWN
DRAWING NO.: C4.1
6 OF 7

Appendix B

Downstream Pipe Capacity

Subbasin 1 - Modeling

According to section 19.02.060 of the Mercer Island municipal code, the maximum impervious surface coverage for the project site (R-8.4 zoning) is 40%. To account for the additional roadway surfaces, the basin was modeled as 45% impervious, 55% pervious (lawn) with moderate slopes. The 100-year flowrate for Subbasin 1 is 1.71 cfs, and the maximum capacity per Hydraflow Express channel flow modeling is 1.72 cfs for the measured 0.7%-slope corrugated metal storm pipe slope within the right-of-way.

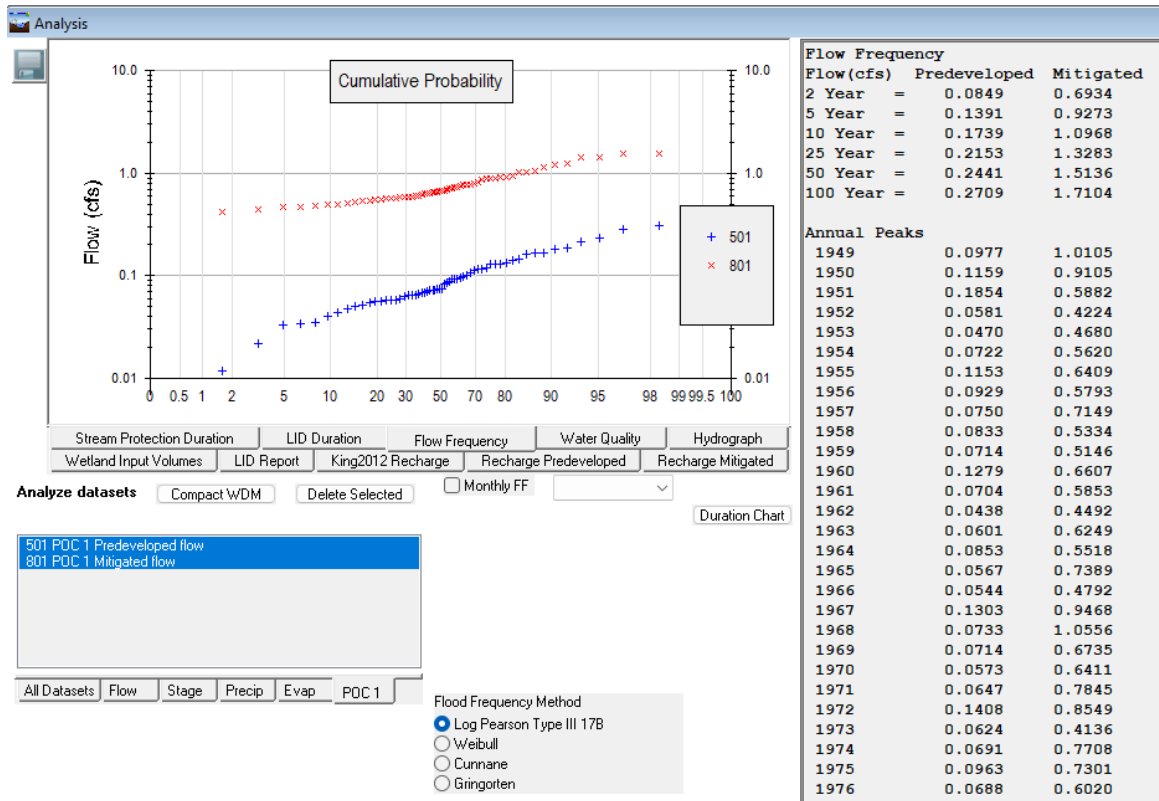

Yusen Residence
Storm Drainage Report

Section	Item	Input
Channel	Section Type =	Circular
	Btm Width (ft)	-0-
	Side Slope, z:1 =	-0-
	Diameter(ft) =	1.00
	Inv Elev(ft) =	100.00
	Slope (%) =	0.70
	n-value =	0.024
Calcs	Compute by =	Q vs Depth
	Increments =	10

Depth	Q	Area	Veloc
(ft)	(cfs)	(sqft)	(ft/s)
0.50	0.813	0.395	2.06
0.60	1.088	0.493	2.21
0.70	1.354	0.588	2.30
0.80	1.578	0.674	2.34
0.90	1.721	0.745	2.31
1.00	1.614	0.785	2.05

The Manning's n-value for a corrugated metal pipe is 0.024.

Subbasin 100-year flow rate = 1.33 cfs

Subbasin 100-year flow rate = 1.71 cfs

0.7% slope, 12" Corrugated Pipe capacity = 1.72 cfs

1.72 cfs > 1.33 cfs

Capacity > 25-yr Tributary Flow Rate → OK

Subbasin 2 – 72nd Ave SE

The existing storm system within 72nd Ave SE adjacent to the project site contains a relatively flat section of the storm system (12" concrete pipe) which may constrain downstream runoff capacity. The tributary subbasin is shown below in green and consists of approximately 607,873 sf (13.955 ac).

Subbasin Map:

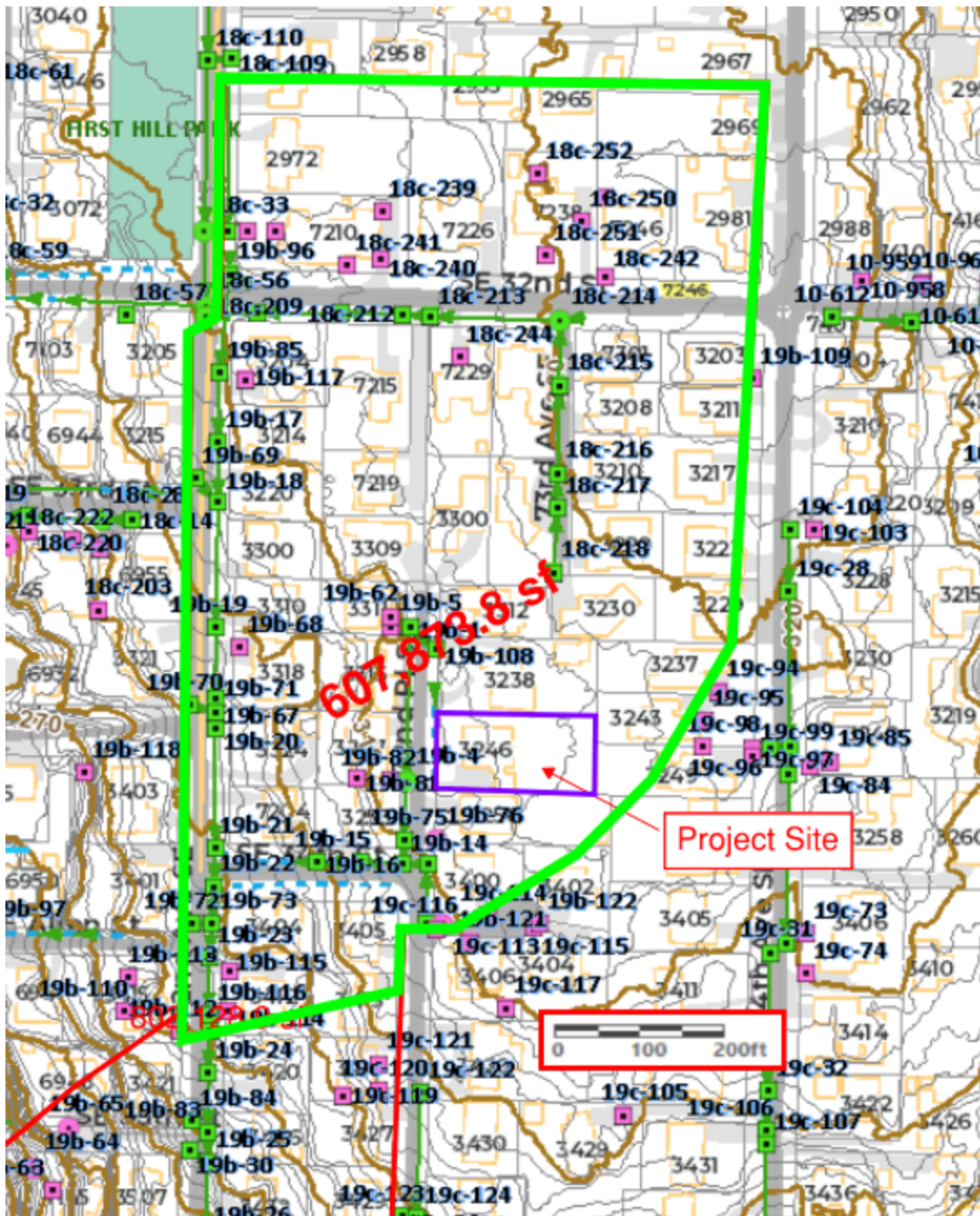

Subbasin 2 - Modeling

According to section 19.02.060 of the Mercer Island municipal code, the maximum impervious surface coverage for the project site (R-8.4 zoning) is 40%. To account for the additional roadway surfaces, the basin was modeled as 45% impervious, 55% pervious (lawn) with moderate slopes. The 100-year flowrate for Subbasin 2 is 8.37 cfs, and the maximum capacity per Hydraflow Express channel flow modeling is 8.40 cfs for a measured 4.17% concrete storm pipe slope.

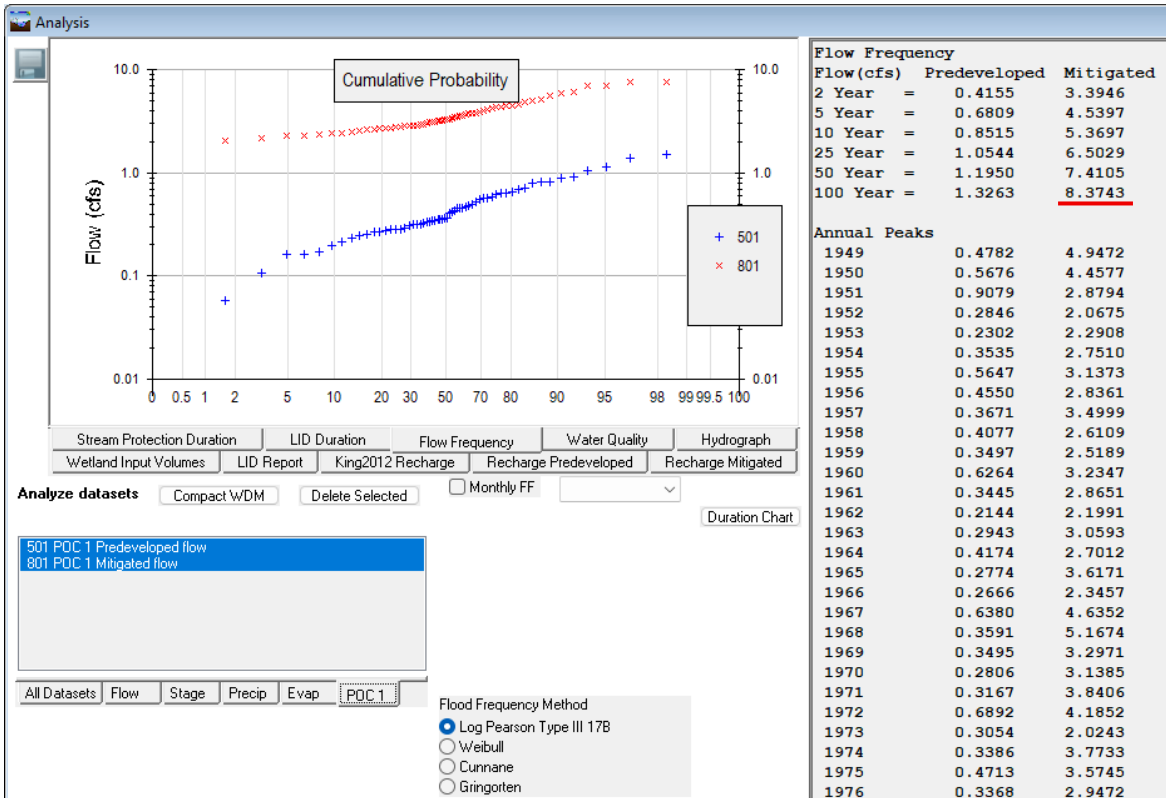

Yusen Residence
Storm Drainage Report

Section	Item	Input
Channel	Section Type =	Circular
	Btm Width (ft)	-0-
	Side Slope, z:1 =	-0-
	Diameter(ft) =	1.00
	Inv Elev(ft) =	100.00
	Slope (%) =	4.17
	n-value =	0.012
Calcs	Compute by =	Q vs Depth
	Increments =	10

Depth	Q	Area	Veloc	Wp	Yc	TopWidth
(ft)	(cfs)	(sqft)	(ft/s)	(ft)	(ft)	(ft)
0.70	6.611	0.588	11.24	1.98	0.97	0.92
0.80	7.704	0.674	11.43	2.22	0.99	0.80
0.90	8.399	0.745	11.28	2.50	0.99	0.60
1.00	7.878	0.785	10.03	3.14	0.99	0.00

The Manning's n-value for a concrete pipe is 0.012.

Subbasin 100-year flow rate = 8.34 cfs
12" Concrete Pipe capacity = 8.40 cfs

8.40 cfs > 8.34 cfs
Capacity > Tributary Flow Rate → OK

Quarter-Mile Downstream Basin - Modeling

According to section 19.02.060 of the Mercer Island municipal code, the maximum impervious surface coverage for residential zoning is 40%. To account for the additional roadway surfaces, the basin was modeled as 45% impervious, 55% pervious (lawn) with moderate slopes. The 50-year flowrate for the tributary basin is 9.77 cfs, and the maximum capacity per Hydraflow Express channel flow modeling is 10.28 cfs for a 25% sloping corrugated metal pipe.

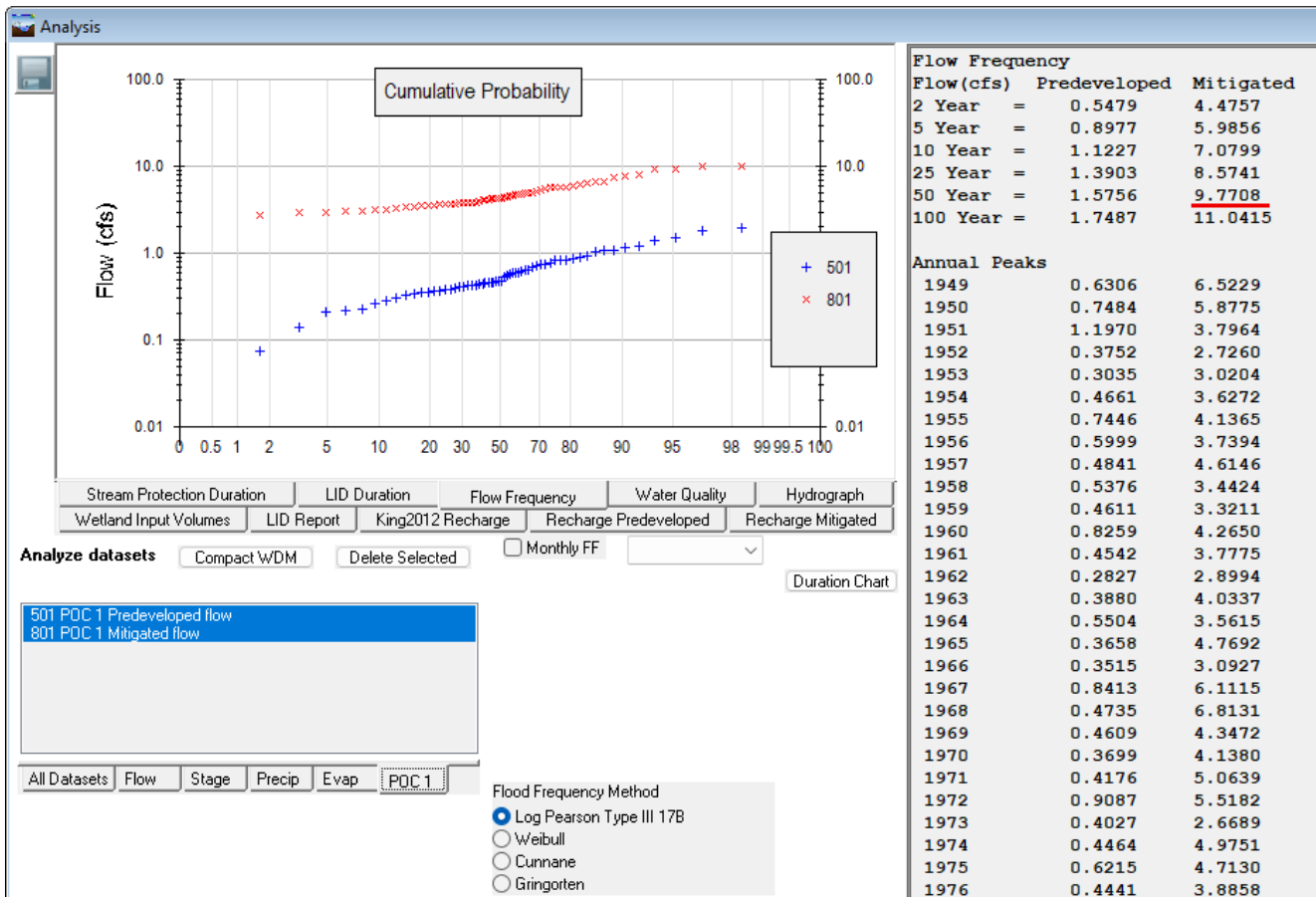

Yusen Residence
Storm Drainage Report

Section	Item	Input
Channel	Section Type =	Circular
	Btm Width (ft)	-0-
	Side Slope, z:1 =	-0-
	Diameter(ft) =	1.00
	Inv Elev(ft) =	100.00
	Slope (%) =	18.00
	n-value =	0.024
Calcs	Compute by =	Q vs Depth
	Increments =	10

Depth	Q	Area	Veloc	Wp	Yc	TopWidth
(ft)	(cfs)	(sqft)	(ft/s)	(ft)	(ft)	(ft)
0.50	4.857	0.395	12.30	1.57	0.91	1.00
0.60	6.503	0.493	13.18	1.77	0.97	0.98
0.70	8.094	0.588	13.76	1.98	0.99	0.92
0.80	9.431	0.674	14.00	2.22	1.00	0.80
0.90	10.28	0.745	13.80	2.50	1.00	0.60
1.00	9.645	0.785	12.28	3.14	1.00	0.00

The Manning's n-value for a corrugated metal pipe is 0.024.

Subbasin 50-year flow rate = 9.77 cfs
12" Corrugated Pipe capacity = 10.28 cfs

10.28 cfs > 9.77 cfs
Capacity > Tributary Flow Rate → OK

Appendix C

Geotechnical Report

October 14, 2025

JN 25304

David and Caitlin Yusen
3246 – 72nd Place S.E.
Mercer Island, WA 98040
via email: davidyusen@outlook.com

Subject: **Geotechnical Engineering Report**
Proposed New Residence
3246 – 72nd Place S.E.
Mercer Island, Washington

Greetings:

This report presents our geotechnical engineering report related to the planned residence to be constructed on the subject property. The scope of our services consisted of assessing the site surface and subsurface conditions, and then developing this geotechnical report.

Based on the information provided by Sturman Architects, the site will be redeveloped with a new two-story residence that will likely be underlain by a basement. The existing house will be demolished as a part of this development. We expect that the main floor elevation will be close to the existing site grades.

SITE CONDITIONS

We visited the subject property on October 7, 2025 to observe the existing conditions and to monitor excavation of exploratory test pits on the property. The subject lot is a rectangular-shaped property situated on the east side of 72nd Place S.E. A two-story residence occupies the western portion of the lot. This structure is two stories in height and does not include a basement. A detached garage is located to the south of the southeastern corner of the house. A paved driveway extends east to this garage from 72nd Place S.E. A patio extends east from the house. The remainder of the property is covered with grass, landscaping, and scattered trees. The eastern portion of the lot appears to once have been used as a garden.

The ground surface on the site and the surrounding lots is relatively flat, with a very slight grade down toward the west. Our review of the City of Mercer Island's GIS confirms that there are no mapped geologically critical areas on, or near, the subject property. This area is not known for historic or recent episodes of slope instability. According to the *Mercer Island Landslide Hazard Assessment*, the nearest documented landslides are over 500 feet east and west of the site.

The property line to the north contains a single-story residence located approximately 7 feet from the common property line. According to King County Assessor records, this house does not have a basement. The home to the south is approximately 5 feet from the property line and contains a basement located approximately 7 feet below grade. Storm as-builts found on the Mercer Island GIS indicate that both the adjacent southern residence (#3256) and the next house to the south (#3400) discharge their storm and subsurface drainage water to the storm sewer located in 72nd Place S.E. Residence #3256 has a pump to discharge collected water.

During our visit to the property, we monitored the excavation of two test pits at the locations shown on the attached Site Exploration Plan. Logs for the test pits are also attached. Test Pit 1, located to the east of the rear patio, found loose, silty sand below a thin layer of sod and topsoil. At a depth of 1.5 feet, this exploration exposed medium-dense, gravelly, silty sand. Below 3 feet, we observed medium-dense, gravelly sand that extended to the 6.5-foot depth of the test pit. Slight caving occurred in the gravelly sand below a depth of 3 feet in this test pit. Test Pit 2 was excavated to the west of the existing residence, and encountered an approximate one-foot thickness of sod and topsoil below the ground surface. The topsoil was underlain by loose, slightly gravelly, silty sand that became medium-dense below a depth of 3 feet. From 4 to 6 feet in depth was medium-dense, slightly gravelly, slightly silty sand, with medium-dense gravelly sand below 6 feet. Slight caving was also observed in the gravelly sand found in the lower portion of this test pit. No groundwater seepage was encountered in the test pits. It is not uncommon to find shallow localized groundwater perched on top of the silty sand following extended wet weather.

CONCLUSIONS AND RECOMMENDATIONS

GENERAL

THIS SECTION CONTAINS A SUMMARY OF OUR STUDY AND FINDINGS FOR THE PURPOSES OF A GENERAL OVERVIEW ONLY. MORE SPECIFIC RECOMMENDATIONS AND CONCLUSIONS ARE CONTAINED IN THE REMAINDER OF THIS REPORT. ANY PARTY RELYING ON THIS REPORT SHOULD READ THE ENTIRE DOCUMENT.

The test holes conducted on the site found competent, medium-dense native soils suitable to support the new house using conventional foundations. It will be important that all foundations be excavated through the topsoil and loose soils. Any soil loosened by the excavation process should be removed from the foundation areas prior to pouring concrete. Where footing subgrades consist of the gravelly sand, we recommend that the subgrade soils be recompact with at least a walk-behind plate compactor to re-densify them.

All floor slabs and other settlement-sensitive on-grade elements should be excavated through the topsoil.

The adjacent house to the south contains a basement and a pumped drainage system. Additionally, the proposed new residence will likely contain a basement. Attempting to use on-site infiltration of storm water for this project would increase the risk of drainage problems for both the proposed and neighboring existing homes. In our professional opinion, the use of onsite infiltration for disposal of storm runoff from impervious surfaces is infeasible for this site.

The erosion hazard for this property is low, due to its relatively flat condition. Even so, proper temporary erosion control measures should be implemented, depending largely on the weather conditions encountered during the site work. If the excavation or areas of bare soil are not below the level of the surrounding properties, a silt fence or straw wattle should be installed around the downslope sides of any work areas. Existing ground cover and landscaping should be left in place wherever possible to minimize the amount of exposed soil. It is prudent to avoid clearing of ground cover until permanent landscaping is to be accomplished. Any soil stockpiles should be covered with plastic during wet weather. Soil and mud should not be tracked onto the adjoining streets, and silty water must be prevented from traveling off the site. As with any construction project, it can be necessary to periodically maintain or modify temporary erosion control measures to address specific site and weather conditions.

We recommend including this report, in its entirety, in the project contract documents. This report should also be provided to any future property owners so they will be aware of our findings and recommendations.

SEISMIC CONSIDERATIONS

In accordance with the International Building Code (IBC), the site class within 100 feet of the ground surface is best represented by Site Class Type D (Stiff Soil).

The IBC and ASCE 7 require that the potential for liquefaction (soil strength loss) during an earthquake be evaluated for the peak ground acceleration of the Maximum Considered Earthquake (MCE), which has a probability of occurring once in 2,475 years (2 percent probability of occurring in a 50-year period). The soils beneath the site are not susceptible to seismic liquefaction under the ground motions of the MCE because of their compact nature and the lack of a near-surface water table.

CONVENTIONAL FOUNDATIONS

An allowable bearing pressure of 2,000 pounds per square foot (psf) is appropriate for new footings supported on dense, native soils. A one-third increase in this design bearing pressure can be used when considering short-term wind or seismic loads. For the above design criteria, it is anticipated that the total post-construction settlement of footings founded on competent native soil will be less than one inch, with differential settlements on the order of one-quarter-inch in a distance of 25 feet along a continuous footing with a uniform load.

Lateral loads due to wind or seismic forces may be resisted by friction between the foundation and the bearing soil, or by passive earth pressure acting on the vertical, embedded portions of the foundation. For the latter condition, the foundation must be either poured directly against relatively level, undisturbed soil or be surrounded by level, well-compacted fill. We recommend using the following ultimate values for the foundation's resistance to lateral loading:

PARAMETER	ULTIMATE VALUE
Coefficient of Friction	0.45
Passive Earth Pressure	300 pcf

Where: pcf is Pounds per Cubic Foot, and Passive Earth Pressure is computed using the Equivalent Fluid Density.

If the ground in front of a foundation is loose or sloping, the passive earth pressure given above will not be appropriate. The above ultimate values for passive earth pressure and coefficient of friction do not include a safety factor.

FOUNDATION AND RETAINING WALLS

Retaining walls backfilled on only one side should be designed to resist the lateral earth pressures imposed by the soil they retain.

The following recommended parameters are for walls that restrain level backfill:

PARAMETER	VALUE
Lateral Earth Pressure *	40 pcf
Passive Earth Pressure	300 pcf
Coefficient of Friction	0.44
Soil Unit Weight	130 pcf

Where: pcf is Pounds per Cubic Foot, and Lateral and Passive Earth Pressures are computed using the Equivalent Fluid Pressures.

* For a restrained wall that cannot deflect at least 0.002 times its height, a uniform lateral pressure equal to 10 psf times the height of the wall should be added to the above lateral equivalent fluid pressure. This applies only to walls with level backfill.

The design values given above do not include the effects of any hydrostatic pressures behind the walls and assume that no surcharges, such as those caused by slopes, vehicles, or adjacent foundations will be exerted on the walls. If these conditions exist, those pressures should be added to the above lateral soil pressures. Where sloping backfill is desired behind the walls, we will need to be given the wall dimensions and the slope of the backfill in order to provide the appropriate design earth pressures. Heavy construction equipment should not be operated behind retaining and foundation walls within a distance equal to the height of a wall, unless the walls are designed for the additional lateral pressures resulting from the equipment.

The values given above are to be used to design only permanent foundation and retaining walls that are to be backfilled, such as conventional walls constructed of reinforced concrete or masonry. It is not appropriate to use the above earth pressures and soil unit weight to back-calculate soil strength parameters for design of other types of retaining walls, such as soldier pile, reinforced earth, modular or soil nail walls. We can assist with the design of these types of walls, if desired.

The passive pressure given is appropriate only for a shear key poured directly against undisturbed native soil, or for the depth of level, well-compacted fill placed in front of a retaining or foundation wall. The values for friction and passive resistance are ultimate values and do not include a safety factor. Restrained wall soil parameters should be utilized for the wall and reinforcing design for a distance of 1.5 times the wall's height from corners or bends in the walls, or from other points of restraint. This is intended to reduce the amount of cracking that can occur where a wall is restrained by a corner.

Wall Pressures Due to Seismic Forces

Per IBC Section 1803.5.12, a seismic surcharge load needs only to be considered in the design of backfilled walls over 6 feet in height. A seismic surcharge load would be imposed by adding a uniform lateral pressure to the above-recommended lateral pressure. The recommended seismic surcharge pressure for this project is $8H$ pounds per square foot (psf), where H is the design retention height of the wall. Using this increased pressure, the safety factor against sliding and overturning can be reduced to 1.2 for the seismic analysis.

Retaining Wall Backfill and Waterproofing

Backfill placed behind retaining or foundation walls should be coarse, free-draining structural fill containing no organics. This backfill should contain no more than 5 percent silt or clay particles and have no gravel greater than 4 inches in diameter. The percentage of particles passing the No. 4 sieve should be between 25 and 70 percent. If the native soils are used as backfill, a minimum 12-inch width of free-draining gravel should be placed against the backfilled retaining walls. The gravel should be hydraulically connected to the foundation drain system. The later section entitled ***Drainage Considerations*** should also be reviewed for recommendations related to subsurface drainage behind foundation and retaining walls.

The purpose of these backfill requirements is to ensure that the design criteria for a retaining wall are not exceeded because of a build-up of hydrostatic pressure behind the wall. Also, subsurface drainage systems are not intended to handle large volumes of water from surface runoff. The top 12 to 18 inches of the backfill should consist of a compacted, relatively impermeable soil or topsoil, or the surface should be paved. The ground surface must also slope away from backfilled walls at one to 2 percent to reduce the potential for surface water to percolate into the backfill.

Water percolating through pervious surfaces (pavers, gravel, permeable pavement, etc.) must also be prevented from flowing toward walls or into the backfill zone. Foundation drainage and waterproofing systems are not intended to handle large volumes of infiltrated water. The compacted subgrade below pervious surfaces and any associated drainage layer should therefore be sloped away. Alternatively, a membrane and subsurface collection system could be provided below a pervious surface.

It is critical that the wall backfill be placed in lifts and be properly compacted, in order for the above-recommended design earth pressures to be appropriate. The recommended wall design criteria assume that the backfill will be well-compacted in lifts no thicker than 12 inches. The compaction of backfill near the walls should be accomplished with hand-operated equipment to prevent the walls from being overloaded by the higher soil forces that occur during compaction.

The above recommendations are not intended to waterproof below-grade walls, or to prevent the formation of mold, mildew or fungi in interior spaces. Over time, the performance of subsurface drainage systems can degrade, subsurface groundwater flow patterns can change, and utilities can break or develop leaks. Therefore, waterproofing should be provided where future seepage through the walls is not acceptable. This typically includes limiting cold-joints and wall penetrations, and using bentonite panels or membranes on the outside of the walls. There are a variety of different waterproofing materials and systems, which should be installed by an experienced contractor familiar with the anticipated construction and subsurface conditions. Applying a thin coat of asphalt emulsion to the outside face of a wall is not considered waterproofing, and will only help to reduce moisture generated from water vapor or capillary action from seeping through the concrete. As with any project, adequate ventilation of basement and crawl space areas is important to prevent a buildup of water vapor that is commonly transmitted through concrete walls from the surrounding soil, even when seepage is not present. This is appropriate even when waterproofing is applied to the outside of foundation and retaining walls. We recommend that you contact an experienced envelope consultant if detailed recommendations or specifications related to waterproofing design, or minimizing the potential for infestations of mold and mildew are desired.

SLABS-ON-GRADE

The building floors can be constructed as slabs-on-grade atop non-organic native soils, or on structural fill placed above this competent soil. The subgrade soil must be in a firm, non-yielding condition at the time of slab construction or underslab fill placement. Any soft areas encountered should be excavated and replaced with select, imported structural fill.

Even where the exposed soils appear dry, water vapor will tend to naturally migrate upward through the soil to the newly constructed space above it. This can affect moisture-sensitive flooring, cause imperfections or damage to the slab, or simply allow excessive water vapor into the space above the slab. All interior slabs-on-grade should be underlain by a capillary break drainage layer consisting of a minimum 4-inch thickness of clean gravel or crushed rock that has a fines content (percent passing the No. 200 sieve) of less than 3 percent and a sand content (percent passing the No. 4 sieve) of no more than 10 percent. Pea gravel or crushed rock are typically used for this layer.

As noted by the American Concrete Institute (ACI) in the *Guides for Concrete Floor and Slab Structures*, proper moisture protection is desirable immediately below any on-grade slab that will be covered by tile, wood, carpet, impermeable floor coverings, or any moisture-sensitive equipment or products. ACI recommends a minimum 10-mil thickness vapor retarder for better durability and long term performance than is provided by 6-mil plastic sheeting that has historically been used. A vapor retarder is defined as a material with a permeance of less than 0.3 perms, as determined by ASTM E 96. It is possible that concrete admixtures may meet this specification, although the manufacturers of the admixtures should be consulted. Where vapor retarders are used under slabs, their edges should overlap by at least 6 inches and be sealed with adhesive tape. The sheeting should extend to the foundation walls for maximum vapor protection.

If no potential for vapor passage through the slab is desired, a vapor *barrier* should be used. A vapor barrier, as defined by ACI, is a product with a water transmission rate of 0.01 perms when tested in accordance with ASTM E 96. Reinforced membranes having sealed overlaps can meet this requirement.

EXCAVATIONS AND SLOPES

Temporary excavation slopes should not exceed the limits specified in local, state, and national government safety regulations. Also, temporary cuts should be planned to provide a minimum of 2 to 3 feet of space for construction of foundations, walls, and drainage. Temporary cuts to a maximum overall depth of about 4 feet may be attempted vertically in the uppermost silty soil, if it is not wet, and if there are no indications of slope instability. However, vertical cuts should not be made near property boundaries, or existing utilities and structures. Considering the slight caving observed in the lower portions of the test pits, vertical cuts should not be attempted below a depth of 3 to 4 feet below the existing grade.

Based upon Washington Administrative Code (WAC) 296, Part N, the near-surface, looser, soil at the subject site would generally be classified as Type B. Therefore, temporary cut slopes greater than 4 feet in height should not be excavated at an inclination steeper than 1:1 (Horizontal:Vertical), extending continuously between the top and the bottom of a cut.

The above-recommended temporary slope inclination is based on the conditions exposed in our explorations, and on what has been successful at other sites with similar soil conditions. It is possible that variations in soil and groundwater conditions will require modifications to the

inclination at which temporary slopes can stand. Temporary cuts are those that will remain unsupported for a relatively short duration to allow for the construction of foundations, retaining walls, or utilities. Temporary cut slopes should be protected with plastic sheeting during wet weather. It is also important that surface runoff be directed away from the top of temporary slope cuts. Cut slopes should also be backfilled or retained as soon as possible to reduce the potential for instability. Please note that loose soil can cave suddenly and without warning. Excavation, foundation, and utility contractors should be made especially aware of this potential danger. These recommendations may need to be modified if the area near the potential cuts has been disturbed in the past by utility installation, or if settlement-sensitive utilities are located nearby.

All permanent cuts into native soil should be inclined no steeper than 2:1 (H:V). Water should not be allowed to flow uncontrolled over the top of any temporary or permanent slope. All permanently exposed slopes should be seeded with an appropriate species of vegetation to reduce erosion and improve the stability of the surficial layer of soil.

DRAINAGE CONSIDERATIONS

Footing drains should be used where: (1) crawl spaces or basements will be below a structure; (2) a slab is below the outside grade; or, (3) the outside grade does not slope downward from a building. Drains should also be placed at the base of all earth-retaining walls. These drains should be surrounded by at least 6 inches of 1-inch-minus, washed rock that is encircled with non-woven, geotextile filter fabric (Mirafi 140N, Supac 4NP, or similar material). At its highest point, a perforated pipe invert should be at least 6 inches below the bottom of a slab floor or the level of a crawl space. The discharge pipe for subsurface drains should be sloped for flow to the outlet point. Roof and surface water drains must not discharge into the foundation drain system. A typical footing drain detail is attached to this report as Plate 4. For the best long-term performance, perforated PVC pipe is recommended for all subsurface drains. Clean-outs should be provided for potential future flushing or cleaning of footing drains.

As a minimum, a vapor retarder, as defined in the **Slabs-On-Grade** section, should be provided in any crawl space area to limit the transmission of water vapor from the underlying soils. Crawl space grades are sometimes left near the elevation of the bottom of the footings. As a result, an outlet drain is recommended for all crawl spaces to prevent an accumulation of any water that may bypass the footing drains. Providing a few inches of free draining gravel underneath the vapor retarder is also prudent to limit the potential for seepage to build up on top of the vapor retarder.

No groundwater was observed during our field work. If seepage is encountered in an excavation, it should be drained from the site by directing it through drainage ditches, perforated pipe, or French drains, or by pumping it from sumps interconnected by shallow connector trenches at the bottom of the excavation.

The excavation and site should be graded so that surface water is directed away from foundations and walls. Water should not be allowed to stand in any area where foundations, slabs, or pavements are to be constructed. Final site grading in areas adjacent to a building should slope away at least one to 2 percent, except where the area is paved. Surface drains should be provided where necessary to prevent ponding of water behind foundation or retaining walls.

LIMITATIONS

This report has been prepared for the exclusive use of the Yusens and their representatives, for specific application to this project and site. Our conclusions and recommendations are professional opinions derived in accordance with our understanding of current local standards of practice, and within the scope of our services. No warranty is expressed or implied. The scope of our services does not include services related to construction safety precautions, and our recommendations are not intended to direct the contractor's methods, techniques, sequences, or procedures, except as specifically described in our report for consideration in design. Our services also do not include assessing or minimizing the potential for biological hazards, such as mold, bacteria, mildew and fungi in either the existing or proposed site development.

ADDITIONAL SERVICES

In addition to reviewing the final plans, Geotech Consultants, Inc. should be retained to provide geotechnical consultation, testing, and observation services during construction. This is to confirm that subsurface conditions are consistent with those indicated by our exploration, to evaluate whether earthwork and foundation construction activities comply with the general intent of the recommendations presented in this report, and to provide suggestions for design changes in the event subsurface conditions differ from those anticipated prior to the start of construction. However, our work would not include the supervision or direction of the actual work of the contractor and its employees or agents. Also, job and site safety, and dimensional measurements, will be the responsibility of the contractor.

During the construction phase, we will provide geotechnical observation and testing services when requested by you or your representatives. Please be aware that we can only document site work we actually observe. It is still the responsibility of your contractor or on-site construction team to verify that our recommendations are being followed, whether we are present at the site or not.

Please contact us if you have any questions regarding this report, or if we can be of further assistance.

Respectfully submitted,
GEOTECH CONSULTANTS, INC.

Marc R. McGinnis, P.E.
Principal



10/14/2025

Attachments:

- Vicinity Map
- Site Exploration Plan
- Test Pit Logs
- Footing Drain Detail

cc: **Sturman Architects** – Kati Eitzman
via email: kati@sturmanarchitects.com
MRM;kg

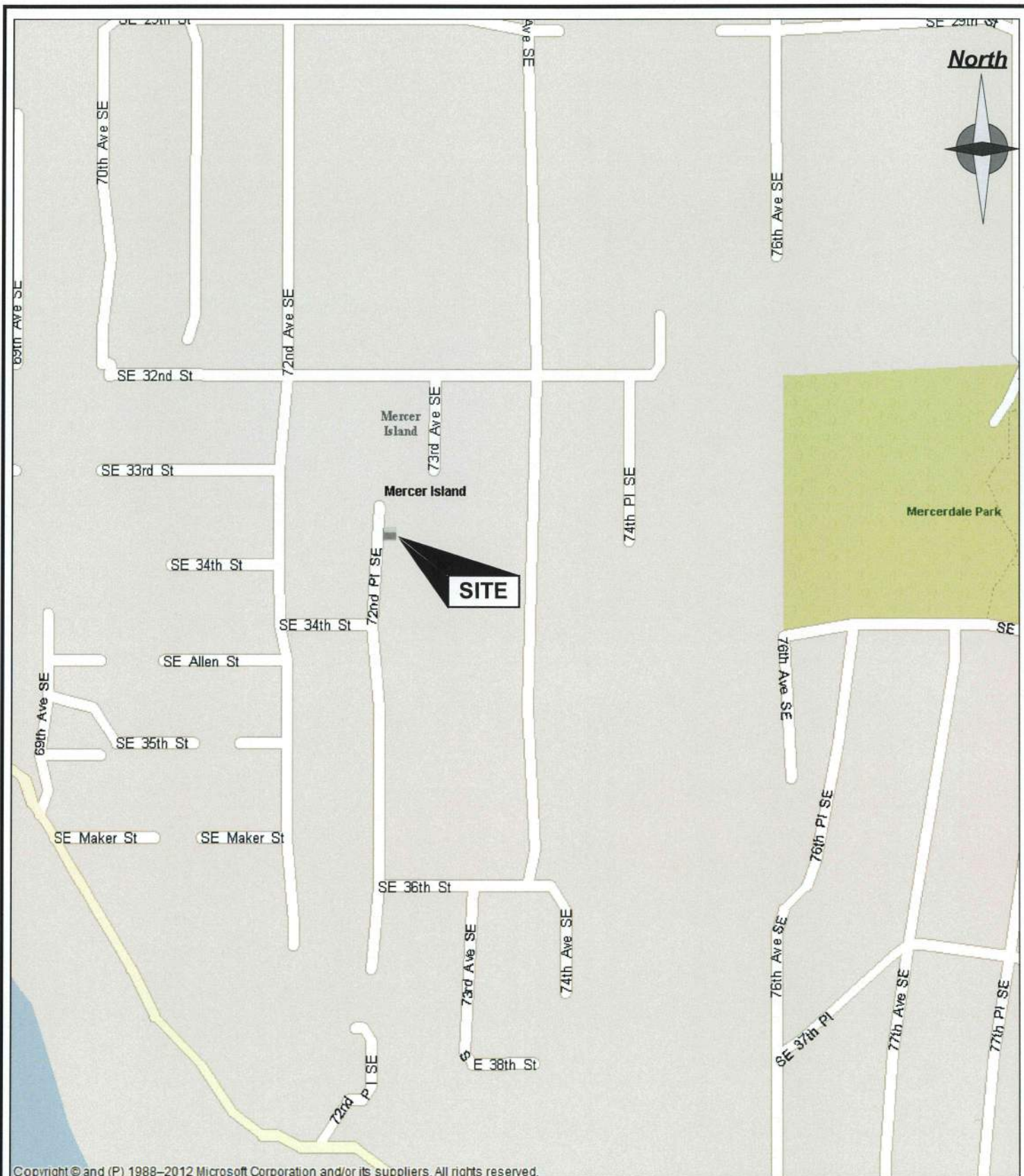

VICINITY MAP
3246 - 72nd Place S.E.
Mercer Island, Washington

Job No: 25304	Date: Oct. 2025	Plate: 1
------------------	--------------------	-------------

North

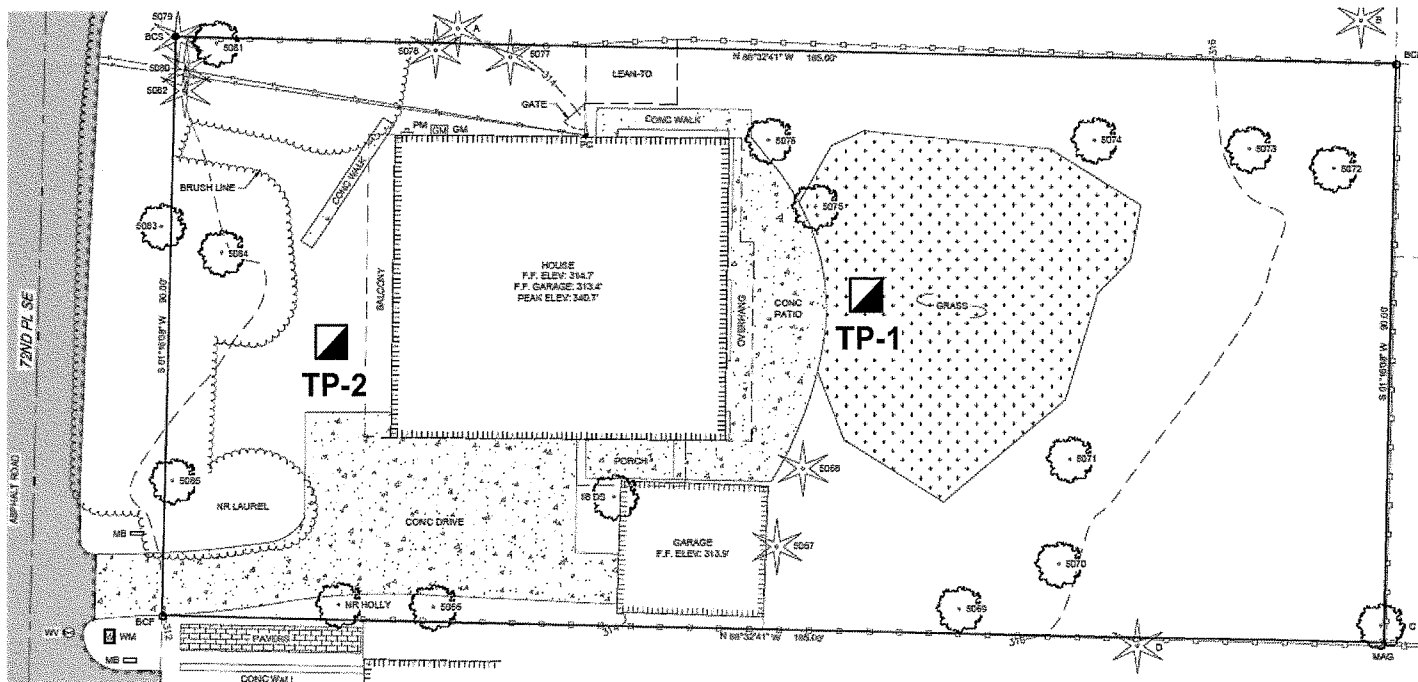
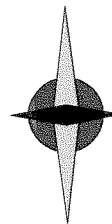

Legend:

▣ TP-1 Test Pit Location



SITE EXPLORATION PLAN
3246 - 72nd Place S.E.
Mercer Island, Washington

Job No: 25304	Date: Oct. 2025	No Scale	Plate: 2
------------------	--------------------	----------	-------------

TEST PIT 1

Depth (feet)	Soil Description
0 – 1.0	Sod over Topsoil
1.0 – 1.5	Orangish-brown, silty SAND, fine-grained, damp, loose
1.5 – 3.0	Brown, gravelly, silty SAND, fine-grained, damp, medium-dense
3.0 – 6.5	Brown, gravelly SAND with cobbles, medium- to coarse-grained, damp, medium-dense

Test Pit was terminated at a depth of 6.5 feet on October 7, 2025.

No groundwater seepage was observed.

Slight caving occurred below 3 feet.

TEST PIT 2

Depth (feet)	Soil Description
0 – 1.0	Sod and Topsoil
1.0 – 4.0	Brown, slightly gravelly, silty SAND with roots, fine-grained, damp, loose -becomes medium-dense with no roots below 3 feet
4.0 – 6.0	Brown, slightly gravelly, slightly silty SAND, fine-grained, damp, medium-dense
6.0 – 7.0	Brown, gravelly SAND with cobbles, damp, medium-dense

Test Pit was terminated at a depth of 7.0 feet on October 7, 2025.

No groundwater seepage was observed.

Slight caving occurred below 6 feet.



TEST PIT LOGS
3246 - 72nd Place S.E.
Mercer Island, Washington

Job No: 25304	Date: Oct. 2025	Plate: 3
------------------	--------------------	-------------

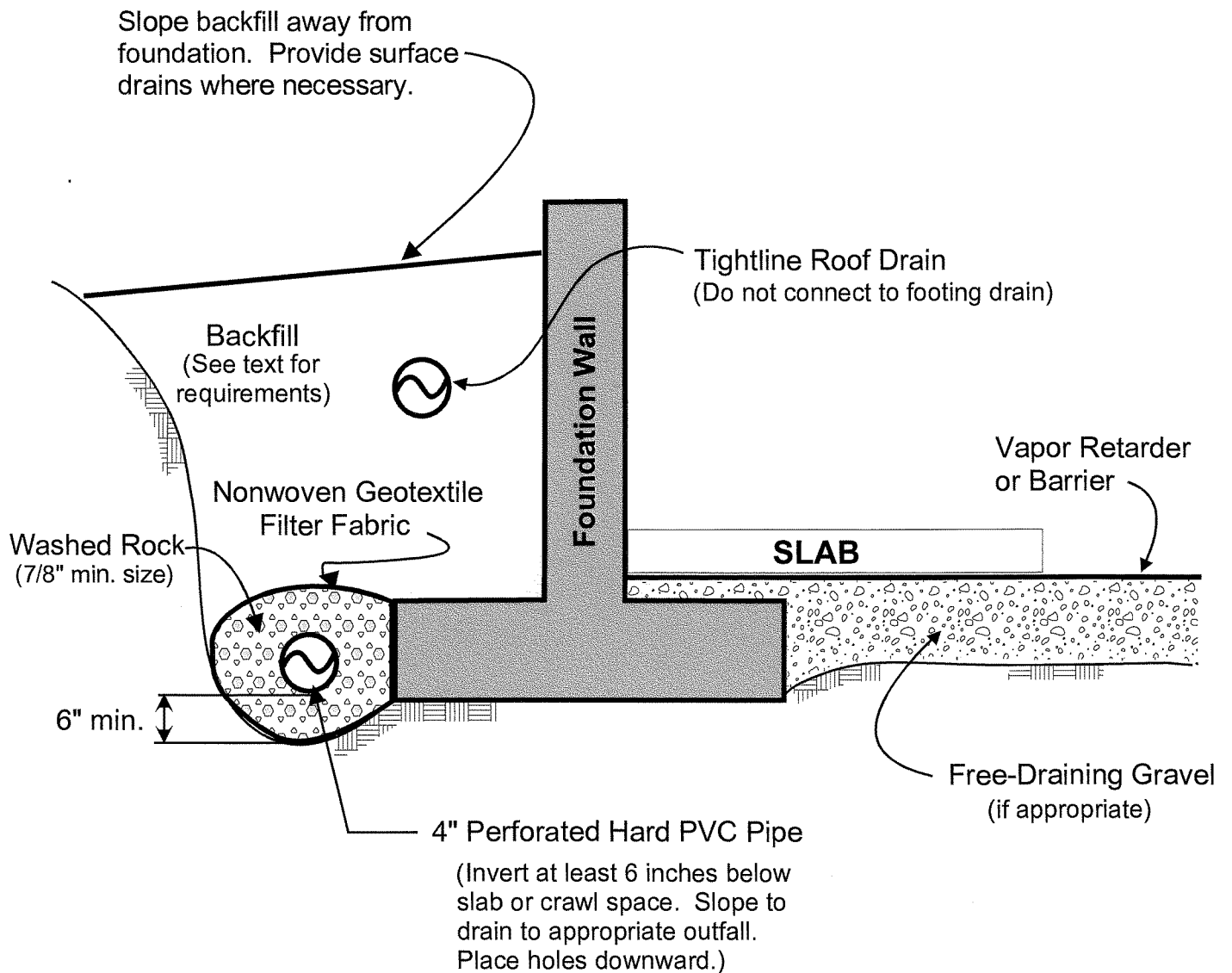

NOTES:

- (1) In crawl spaces, provide an outlet drain to prevent buildup of water that bypasses the perimeter footing drains.
- (2) Refer to report text for additional drainage and waterproofing considerations.



FOOTING DRAIN DETAIL
3246 - 72nd Place S.E.
Mercer Island, Washington

Job No: 25304	Date: Oct. 2025	Plate: 4
------------------	--------------------	-------------

Appendix D

Construction Stormwater Pollution Prevention Plan (CSWPPP)

Construction Stormwater General Permit (CSWGP)

Stormwater Pollution Prevention Plan (SWPPP)

for
Yusen Residence

Prepared for:
Department of Ecology
Northwest Regional Office (Shoreline)

Permittee / Owner	Developer	Operator / Contractor
David & Caitlin Yusen		

3246 72nd Place SE
Mercer Island, WA 98040

Certified Erosion and Sediment Control Lead (CESCL)

Name	Organization	Contact Phone Number

SWPPP Prepared By

Name	Organization	Contact Phone Number
Nick Millman	Patrick Harron & Associates	(206) 674-4659

SWPPP Preparation Date

4/7/2026

Project Construction Dates

Activity / Phase	Start Date	End Date

GENERAL INSTRUCTIONS AND CAVEATS

This template presents the recommended structure and content for preparation of a Construction Stormwater General Permit (CSWGP) Stormwater Pollution Prevention Plan (SWPPP).

The Department of Ecology's (Ecology) CSWGP requirements inform the structure and content of this SWPPP template; however, **you must customize this template to reflect the conditions of your site.**

A Construction Stormwater Site Inspection Form can be found on Ecology's website.
<https://www.ecology.wa.gov/Regulations-Permits/Permits-certifications/Stormwater-general-permits/Construction-stormwater-permit>

Using the SWPPP Template

Each section will include instructions and space for information specific to your project. Please read the instructions for each section and provide the necessary information when prompted. This Word template can be modified electronically. You may add/delete text, copy and paste, edit tables, etc. Some sections may be completed with brief answers while others may require several pages of explanation.

INSTRUCTIONS

Instructions are identified by gray shading, and should **be deleted upon SWPPP completion.**
Delete this entire section upon SWPPP completion.

Follow this link to a copy of the Construction Stormwater General Permit:

<https://www.ecology.wa.gov/Regulations-Permits/Permits-certifications/Stormwater-general-permits/Construction-stormwater-permit>

Table of Contents

List of Tables

List of Appendices

List of Acronyms and Abbreviations

Acronym / Abbreviation	Explanation
303(d)	Section of the Clean Water Act pertaining to Impaired Waterbodies
BFO	Bellingham Field Office of the Department of Ecology
BMP(s)	Best Management Practice(s)
CESCL	Certified Erosion and Sediment Control Lead
CO₂	Carbon Dioxide
CRO	Central Regional Office of the Department of Ecology
CSWGP	Construction Stormwater General Permit
CWA	Clean Water Act
DMR	Discharge Monitoring Report
DO	Dissolved Oxygen
Ecology	Washington State Department of Ecology
EPA	United States Environmental Protection Agency
ERO	Eastern Regional Office of the Department of Ecology
ERTS	Environmental Report Tracking System
ESC	Erosion and Sediment Control
GULD	General Use Level Designation
NPDES	National Pollutant Discharge Elimination System
NTU	Nephelometric Turbidity Units
NWRO	Northwest Regional Office of the Department of Ecology
pH	Power of Hydrogen
RCW	Revised Code of Washington
SPCC	Spill Prevention, Control, and Countermeasure
su	Standard Units
SWMMEW	Stormwater Management Manual for Eastern Washington
SWMMWW	Stormwater Management Manual for Western Washington
SWPPP	Stormwater Pollution Prevention Plan
TESC	Temporary Erosion and Sediment Control
SWRO	Southwest Regional Office of the Department of Ecology
TMDL	Total Maximum Daily Load
VFO	Vancouver Field Office of the Department of Ecology
WAC	Washington Administrative Code
WSDOT	Washington Department of Transportation
WWHM	Western Washington Hydrology Model

Project Information (1.0)

Project/Site Name: **Yusen Residence**

Street/Location: **3246 72nd Place SE (Parcel: 130030-0840)**

City: **Mercer Island** State: **WA** Zip code: **98040**

Subdivision:

Receiving waterbody: **Lake Washington**

Existing Conditions (1.1)

Total acreage (including support activities such as off-site equipment staging yards, material storage areas, borrow areas).

Total acreage: **0.38 acres**

Disturbed acreage: **0.28 acres**

Existing structures: **Residence with walkways & driveway**

Landscape topography: **Slopes to the west, approx. 2-4% slopes**

Drainage patterns: **Drains to existing storm system within 72nd PI. SE**

Existing Vegetation: **Lawn and trees**

Critical Areas (wetlands, streams, high erosion risk, steep or difficult to stabilize slopes):
No Critical Areas on or adjacent to the project property, but there are points of potentially constrained capacity within the existing storm system downstream of the site. Tributary runoff is analyzed in Appendix B of this report.

List of known impairments for 303(d) listed or Total Maximum Daily Load (TMDL) for the receiving waterbody:

Table 1 includes a list of suspected and/or known contaminants associated with the construction activity.

Table 1 – Summary of Site Pollutant Constituents

Constituent (Pollutant)	Location	Depth	Concentration

Proposed Construction Activities (1.2)

Description of site development (example: subdivision):

New single-family residence proposed, along with porch, walkways, and driveway.

Description of construction activities (example: site preparation, demolition, excavation):

In addition to construction of the new single-family residence with basement, porch, and driveway, a duplex stormwater pump system is proposed to convey runoff from the basement footing drain.

Description of site drainage including flow from and onto adjacent properties. Must be consistent with Site Map in Appendix A:

Trace runoff is expected from neighboring properties to the east, but is not expected to meaningfully impact the proposed development.

Description of final stabilization (example: extent of revegetation, paving, landscaping):

Disturbed soils will be amended.

Contaminated Site Information:

Proposed activities regarding contaminated soils or groundwater (example: on-site treatment system, authorized sanitary sewer discharge):

There are no contaminated soils or groundwater on the project site to our knowledge.

Construction Stormwater Best Management Practices (BMPs) (2.0)

Describe the BMPs identified to control pollutants in stormwater discharges. Depending on the site, multiple BMPs for each element may be necessary. For each element identified:

- Clearly describe the control measure(s).
- Describe the implementation sequence.
- Describe the inspection and maintenance procedures for that specific BMP.
- Identify the responsible party for maintaining BMPs (if your SWPPP is shared by multiple operators, indicate the operator responsible for each BMP).

Categorize each BMP under one of the following elements as listed below:

1. Preserve Vegetation / Mark Clearing Limits
2. Establish Construction Access
3. Control Flow Rates
4. Install Sediment Controls
5. Stabilize Soils
6. Protect Slopes
7. Protect Drain Inlets
8. Stabilize Channels and Outfalls
9. Control Pollutants
10. Control Dewatering
11. Maintain BMPs
12. Manage the Project
13. Protect Low Impact Development

- BMPs must be consistent with the most current approved edition of the Stormwater Management Manual for Western Washington (SWMMWW) at sites west of the crest of the Cascade Mountains; the Stormwater Management Manual for Eastern Washington (SWMMEW) for sites east of the crest of the Cascade Mountains at the time the general permit was issued; or other Ecology-approved manual.
- Note the location of each BMP on your Site Map in Appendix A.
- Include the corresponding Ecology source control BMPs and runoff conveyance and treatment BMPs in Appendix B.
 - SWMMWW Volume II Chapter 4 Sections 4.1 and 4.2 – <https://fortress.wa.gov/ecy/publications/SummaryPages/1410055.html> or
 - SWMMEW Chapter 7 Section 7.3.1 and 7.3.2 – <https://fortress.wa.gov/ecy/publications/summarypages/0410076.html>
 - If it can be justified that a particular element does not apply to the project site, include a written justification in lieu of the BMP description in the text for the appropriate element.

The SWPPP is a living document reflecting current conditions and changes throughout the life of the project. These changes may be informal (i.e. hand-written notes and deletions). Update the SWPPP when the CESCL has noted a deficiency in BMPs or deviation from original design.

The 12 Elements (2.1)

Element 1: Preserve Vegetation / Mark Clearing Limits (2.1.1)

Describe the methods (signs, fences, etc.) you will use to protect those areas that should not be disturbed.

Describe natural features identified and how each will be protected during construction. Trees that are to be preserved, as well as all sensitive areas and their buffers, shall be clearly delineated, both in the field and on the plans.

Describe how natural vegetation and native topsoil will be preserved.

List and describe BMPs: **Clearing limits will be marked with construction fencing.**

Installation Schedules: **TBD**

Inspection and Maintenance plan: **TBD**

Responsible Staff: **TBD**

Element 2: Establish Construction Access (2.1.2)

Describe how you will minimize dust generation and vehicles tracking sediment off-site.

Limit vehicle access to one route, if possible.

Recycled concrete used to establish construction ingress or egress may be a stormwater pollutant source that requires treatment prior to discharge.

Street sweeping, street cleaning, or wheel wash/tire baths may be necessary if the stabilized construction access is not effective. All wheel wash wastewater shall be controlled on-site and CANNOT be discharged into waters of the State.

Install site ingress/egress stabilization BMPs according to BMP C105.

Describe how you will clean the affected roadway(s) from sediment which is tracked off-site.

List and describe BMPs: **A stabilized construction entrance is to be installed and utilized for construction access.**

Installation Schedules: **TBD**

Inspection and Maintenance plan: **TBD**

Responsible Staff: **TBD**

Element 3: Control Flow Rates (2.1.3)

Describe how you will protect properties and waterways downstream of the project from increased speed and volume of stormwater discharges due to construction activity.

Construction of stormwater retention and/or detention facilities must be done as one of the first steps in grading.

Assure that detention facilities are functioning properly before constructing site improvements (i.e. impervious surfaces).

If applicable, describe how you will protect areas designed for infiltration from siltation during the construction phase.

Will you construct stormwater retention and/or detention facilities?

Yes No

Will you use permanent infiltration ponds or other low impact development (example: rain gardens, bio-retention, porous pavement) to control flow during construction?

Yes No

List and describe BMPs: **A temporary silt fence will be installed along the west edge of the construction area to control flow rates leaving the site.**

Installation Schedules: **TBD**

Inspection and Maintenance plan: **TBD**

Responsible Staff: **TBD**

Element 4: Install Sediment Controls (2.1.4)

Describe how you will minimize sediment discharges from the site. Construct sediment control BMPs as one of the first steps of grading. These BMPs must be functional before other land disturbing activities – especially grading and filling – take place.

Describe the BMPs identified to filter sediment prior to it being discharged to an infiltration system or leaving the construction site.

Describe how you will direct stormwater for maximum infiltration where feasible.

Describe how you will not interfere with the movement of juvenile Salmonids attempting to enter off-channel areas or drainages.

Describe how you will respond if sediment controls are ineffective and turbid water is observed discharging from the site.

Consider the amount, frequency, intensity and duration of precipitation, soil characteristics, and site characteristics when selecting sediment control BMPs.

List and describe BMPs: **Temporary silt fencing will be installed along portions of the northern and southern edges of the property to restrict the potential for sediment to leave the site. Inlet protection will also be put in place for the duration of construction.**

Installation Schedules: **TBD**

Inspection and Maintenance plan: **TBD**

Responsible Staff: **TBD**

Element 5: Stabilize Soils (2.1.5)

Describe how you will stabilize exposed and unworked soils throughout the life of the project (i.e. temporary and permanent seeding, mulching, erosion control fabrics, etc.).

Describe how you will stabilize soil stockpiles.

Describe how you will minimize the amount of soil exposed throughout the life of the project.

Describe how you will minimize the disturbance of steep slopes.

Describe how you will minimize soil compaction.

Describe how you will stabilize contaminated soil and contaminated soil stockpiles if applicable.

Exposed and unworked soils will be stabilized according to the time period set forth for dry and wet seasons, on the west or east sides of the crest of the Cascade Mountains.

West of the Cascade Mountains Crest

Season	Dates	Number of Days Soils Can be Left Exposed
During the Dry Season	May 1 – September 30	7 days
During the Wet Season	October 1 – April 30	2 days

Soils must be stabilized at the end of the shift before a holiday or weekend if needed based on the weather forecast.

Anticipated project dates: Start date: **TBD** End date: **TBD**

Will you construct during the wet season?

Yes No

List and describe BMPs:

Installation Schedules: **TBD**

Inspection and Maintenance plan: **TBD**

Responsible Staff: **TBD**

Element 6: Protect Slopes (2.1.6)

West of the Cascade Mountains Crest

Describe how slopes will be designed, constructed, and protected to minimize erosion.

Temporary pipe slope drains must handle the peak 10-minute flow rate from a Type 1A, 10-year, 24-hour frequency storm for the developed condition. Alternatively, the 10-year, 1-hour flow rate predicted by an approved continuous runoff model, increased by a factor of 1.6, may be used.

The hydrologic analysis must use the existing land cover condition for predicting flow rates from tributary areas outside the project limits.

For tributary areas on the project site, the analysis must use the temporary or permanent project land cover condition, whichever will produce the highest flow rates.

If using the Western Washington Hydrology Model (WWHM) to predict flows, bare soil areas should be modeled as “landscaped area”.

Describe how you will reduce scouring within constructed channels that are cut down a slope.

Will steep slopes be present at the site during construction?

Yes No

List and describe BMPs: **No steep slopes are present on or adjacent to the project property.**

Installation Schedules: **TBD**

Inspection and Maintenance plan: **TBD**

Responsible Staff: **TBD**

Element 7: Protect Drain Inlets (2.1.7)

Describe how you will protect all operable storm drain inlets so that stormwater runoff does not enter the stormwater conveyance system.

Describe how you will remove sediment that enters the stormwater conveyance system (i.e. filtration, treatment, etc.).

Keep in mind inlet protection may function well for coarse sediment but is less effective in filtering finer particles and dissolved constituents. Inlet protection is the last component of a treatment train and protection of drain inlets include additional sediment and erosion control measures. Inlet protection devices will be cleaned (or removed and replaced), when sediment has filled the device by one third (1/3) or as specified by the manufacturer.

Inlets will be inspected weekly at a minimum and daily during storm events.

List and describe BMPs:	Inlet protection to be installed as applicable for the duration of construction.
Installation Schedules:	TBD
Inspection and Maintenance plan:	TBD
Responsible Staff:	TBD

Element 8: Stabilize Channels and Outlets (2.1.8)

Describe how you will prevent downstream erosion where site runoff is to be conveyed in channels, discharged to a stream or, discharged to a natural drainage point.

West of the Cascade Mountains Crest

On-site conveyance channels must handle the peak 10-minute flow rate from a Type 1A, 10-year, 24-hour frequency storm for the developed condition. Alternatively, the 10-year, 1-hour flow rate predicted by an approved continuous runoff model, increased by a factor of 1.6, may be used.

The hydrologic analysis must use the existing land cover condition for predicting flow rates from tributary areas outside the project limits.

For tributary areas on the project site, the analysis must use the temporary or permanent project land cover condition, whichever will produce the highest flow rates.

If using the WWHM to predict flows, bare soil areas should be modeled as “landscaped area”.

Provide stabilization, including armoring material, adequate to prevent erosion of outlets, adjacent stream banks, slopes, and downstream reaches, will be installed at the outlets of all conveyance systems.

List and describe BMPs: **Not applicable.**

Installation Schedules: **Not applicable.**

Inspection and Maintenance plan: **Not applicable.**

Responsible Staff: **Not applicable.**

Element 9: Control Pollutants (2.1.9)

The following pollutants are anticipated to be present on-site:

Table 2 – Pollutants

Pollutant (and source, if applicable)
[List pollutants here]

Describe how you will handle and dispose of all pollutants, including waste materials and demolition debris, in a manner that does not cause contamination of stormwater.

Describe how you will cover, contain, and protect from vandalism all chemicals, liquid products, petroleum products, and other polluting materials.

Describe how you will manage known contaminants to prevent their discharge with stormwater to waters of the State (i.e. treatment system, off-site disposal).

List and describe BMPs:

Installation Schedules:

Inspection and Maintenance plan:

Responsible Staff:

Will maintenance, fueling, and/or repair of heavy equipment and vehicles occur on-site?

Yes **No**

If yes, describe spill prevention and control measures in place while conducting maintenance, fueling, and repair of heavy equipment and vehicles.

If yes, also provide the total volume of fuel on-site and capacity of the secondary containment for each fuel tank. Secondary containment structures shall be impervious.

List and describe BMPs:

Installation Schedules:

Inspection and Maintenance plan:

Responsible Staff:

Will wheel wash or tire bath system BMPs be used during construction?

Yes **No**

If yes, provide disposal methods for wastewater generated by BMPs.

If discharging to the sanitary sewer, include the approval letter from your local sewer district under Correspondence in Appendix C.

List and describe BMPs:

Installation Schedules:

Inspection and Maintenance plan:

Responsible Staff:

Will pH-modifying sources be present on-site?

Yes No If yes, check the source(s).

Table 3 – pH-Modifying Sources

<input type="checkbox"/>	None
<input type="checkbox"/>	Bulk cement
<input type="checkbox"/>	Cement kiln dust
<input type="checkbox"/>	Fly ash
<input type="checkbox"/>	Other cementitious materials
<input type="checkbox"/>	New concrete washing or curing waters
<input type="checkbox"/>	Waste streams generated from concrete grinding and sawing
<input type="checkbox"/>	Exposed aggregate processes
<input type="checkbox"/>	Dewatering concrete vaults
<input type="checkbox"/>	Concrete pumping and mixer washout waters
<input type="checkbox"/>	Recycled concrete
<input type="checkbox"/>	Other (i.e. calcium lignosulfate) [please describe]

Describe BMPs you will use to prevent pH-modifying sources from contaminating stormwater.

List and describe BMPs:

Installation Schedules:

Inspection and Maintenance plan:

Responsible Staff:

Adjust pH of stormwater if outside the range of 6.5 to 8.5 su.

Obtain written approval from Ecology before using chemical treatment with the exception of CO₂ or dry ice to modify pH.

Concrete trucks must not be washed out onto the ground, or into storm drains, open ditches, streets, or streams. Excess concrete must not be dumped on-site, except in designated concrete washout areas with appropriate BMPs installed.

Element 10: Control Dewatering (2.1.10)

Describe where dewatering will occur, including source of the water to be removed. State clearly if dewatering water is contaminated or has the potential to be contaminated.

Water from foundations, vaults, and trenches with characteristics similar to stormwater runoff shall be discharged into a controlled conveyance system before discharging to a sediment trap or sediment pond. Clean dewatering water will not be routed through stormwater sediment ponds.

Only clean, non-turbid dewatering water (such as well-point groundwater) may be discharged to systems tributary to, or directly into, surface waters of the State, provided the dewatering flow does not cause erosion or flooding of receiving waters.

Describe how you will manage dewatering water to prevent the discharge of contaminants to waters of the State, including dewatering water that has comingled with stormwater (i.e. treatment system, off-site disposal).

Check treatment or disposal option for dewatering water, if applicable:

Table 4 – Dewatering BMPs

	Infiltration
	Transport off-site in a vehicle (vacuum truck for legal disposal)
	Ecology-approved on-site chemical treatment or other suitable treatment technologies
	Sanitary or combined sewer discharge with local sewer district approval (last resort)
	Use of sedimentation bag with discharge to ditch or swale (small volumes of localized dewatering)

List and describe BMPs:

Installation Schedules:

Inspection and Maintenance plan:

Responsible Staff:

Element 11: Maintain BMPs (2.1.11)

This section is a list of permit requirements and does not have to be filled out.

All temporary and permanent Erosion and Sediment Control (ESC) BMPs shall be maintained and repaired as needed to ensure continued performance of their intended function.

Maintenance and repair shall be conducted in accordance with each particular BMP specification (see *Volume II of the SWMMWW* or *Chapter 7 of the SWMMEW*).

Visual monitoring of all BMPs installed at the site will be conducted at least once every calendar week and within 24 hours of any stormwater or non-stormwater discharge from the site. If the site becomes inactive and is temporarily stabilized, the inspection frequency may be reduced to once every calendar month.

All temporary ESC BMPs shall be removed within 30 days after final site stabilization is achieved or after the temporary BMPs are no longer needed.

Trapped sediment shall be stabilized on-site or removed. Disturbed soil resulting from removal of either BMPs or vegetation shall be permanently stabilized.

Additionally, protection must be provided for all BMPs installed for the permanent control of stormwater from sediment and compaction. BMPs that are to remain in place following completion of construction shall be examined and restored to full operating condition. If sediment enters these BMPs during construction, the sediment shall be removed and the facility shall be returned to conditions specified in the construction documents.

Element 12: Manage the Project (2.1.12)

The project will be managed based on the following principles:

- Projects will be phased to the maximum extent practicable and seasonal work limitations will be taken into account.
- Inspection and monitoring:
 - Inspection, maintenance and repair of all BMPs will occur as needed to ensure performance of their intended function.
 - Site inspections and monitoring will be conducted in accordance with Special Condition S4 of the CSWGP. Sampling locations are indicated on the [Site Map](#). Sampling station(s) are located in accordance with applicable requirements of the CSWGP.
- Maintain an updated SWPPP.
 - The SWPPP will be updated, maintained, and implemented in accordance with Special Conditions S3, S4, and S9 of the CSWGP.

As site work progresses the SWPPP will be modified routinely to reflect changing site conditions. The SWPPP will be reviewed monthly to ensure the content is current.

Check all the management BMPs that apply at your site:

Table 5 – Management

	Design the project to fit the existing topography, soils, and drainage patterns
	Emphasize erosion control rather than sediment control
	Minimize the extent and duration of the area exposed
	Keep runoff velocities low
	Retain sediment on-site
	Thoroughly monitor site and maintain all ESC measures
	Schedule major earthwork during the dry season
	Other (please describe)

Element 13: Protect Low Impact Development (LID) BMPs (2.1.13)

Describe LIDs.

Permittees must protect all Bioretention and Rain Garden facilities from sedimentation through installation and maintenance of erosion and sediment control BMPs on portions of the site that drain into the Bioretention and/or Rain Garden facilities. Restore the facilities to their fully functioning condition if they accumulate sediment during construction. Restoring the facility must include removal of sediment and any sediment-laden Bioretention/Rain Garden soils, and replacing the removed soils with soils meeting the design specification.

Permittees must maintain the infiltration capabilities of Bioretention and Rain Garden facilities by protecting against compaction by construction equipment and foot traffic. Protect completed lawn and landscaped areas from compaction due to construction equipment.

Permittees must control erosion and avoid introducing sediment from surrounding land uses onto permeable pavements. Do not allow muddy construction equipment on the base material or pavement. Do not allow sediment-laden runoff onto permeable pavements.

Permittees must clean permeable pavements fouled with sediments or no longer passing an initial infiltration test using local stormwater manual methodology or the manufacturer's procedures.

Permittees must keep all heavy equipment off existing soils under LID facilities that have been excavated to final grade to retain the infiltration rate of the soils.

Describe how you will protect LID facilities from sedimentation, protect soils from compaction, and maintain the infiltration capabilities.

Describe how you will clean permeable pavements fouled with sediments.

Pollution Prevention Team (3.0)

Table 7 – Team Information

Title	Name(s)	Phone Number
Certified Erosion and Sediment Control Lead (CESCL)		
Resident Engineer		
Emergency Ecology Contact		
Emergency Permittee/ Owner Contact		
Non-Emergency Owner Contact		
Monitoring Personnel		
Ecology Regional Office		

Monitoring and Sampling Requirements (4.0)

Monitoring includes visual inspection, sampling for water quality parameters of concern, and documentation of the inspection and sampling findings in a site log book. A site log book will be maintained for all on-site construction activities and will include:

- A record of the implementation of the SWPPP and other permit requirements
- Site inspections
- Stormwater sampling data

Create your own Site Inspection Form or use the Construction Stormwater Site Inspection Form found on Ecology's website. <https://www.ecology.wa.gov/Regulations-Permits/Permits-certifications/Stormwater-general-permits/Construction-stormwater-permit>

File a blank form under Appendix D.

The site log book must be maintained on-site within reasonable access to the site and be made available upon request to Ecology or the local jurisdiction.

Numeric effluent limits may be required for certain discharges to 303(d) listed waterbodies. See CSWGP Special Condition S8 and Section 5 of this template.

Complete the following paragraph for sites that discharge to impaired waterbodies for fine sediment, turbidity, phosphorus, or pH:

The receiving waterbody, insert waterbody name, is impaired for: insert impairment. All stormwater and dewatering discharges from the site are subject to an **effluent limit** of 8.5 su for pH and/or 25 NTU for turbidity.

Site Inspection (4.1)

Site inspections will be conducted at least once every calendar week and within 24 hours following any discharge from the site. For sites that are temporarily stabilized and inactive, the required frequency is reduced to once per calendar month.

The discharge point(s) are indicated on the Site Map (see Appendix A) and in accordance with the applicable requirements of the CSWGP.

Stormwater Quality Sampling (4.2)

Turbidity Sampling (4.2.1)

Requirements include calibrated turbidity meter or transparency tube to sample site discharges for compliance with the CSWGP. Sampling will be conducted at all discharge points at least once per calendar week.

Method for sampling turbidity:

Check the analysis method you will use:

Table 8 – Turbidity Sampling Method

	Turbidity Meter/Turbidimeter (required for disturbances 5 acres or greater in size)
	Transparency Tube (option for disturbances less than 1 acre and up to 5 acres in size)

The benchmark for turbidity value is 25 nephelometric turbidity units (NTU) and a transparency less than 33 centimeters.

If the discharge's turbidity is 26 to 249 NTU **or** the transparency is less than 33 cm but equal to or greater than 6 cm, the following steps will be conducted:

1. Review the SWPPP for compliance with Special Condition S9. Make appropriate revisions within 7 days of the date the discharge exceeded the benchmark.
2. Immediately begin the process to fully implement and maintain appropriate source control and/or treatment BMPs as soon as possible. Address the problems within 10 days of the date the discharge exceeded the benchmark. If installation of necessary treatment BMPs is not feasible within 10 days, Ecology may approve additional time when the Permittee requests an extension within the initial 10-day response period.
3. Document BMP implementation and maintenance in the site log book.

If the turbidity exceeds 250 NTU **or** the transparency is 6 cm or less at any time, the following steps will be conducted:

1. Telephone or submit an electronic report to the applicable Ecology Region's Environmental Report Tracking System (ERTS) within 24 hours.
<https://www.ecology.wa.gov/About-us/Get-involved/Report-an-environmental-issue>
 - Central Region (Benton, Chelan, Douglas, Kittitas, Klickitat, Okanogan, Yakima): (509) 575-2490
 - Eastern Region (Adams, Asotin, Columbia, Ferry, Franklin, Garfield, Grant, Lincoln, Pend Oreille, Spokane, Stevens, Walla Walla, Whitman): (509) 329-3400
 - Northwest Region (King, Kitsap, Island, San Juan, Skagit, Snohomish, Whatcom): (425) 649-7000
 - Southwest Region (Clallam, Clark, Cowlitz, Grays Harbor, Jefferson, Lewis, Mason, Pacific, Pierce, Skamania, Thurston, Wahkiakum.): (360) 407-6300
2. Immediately begin the process to fully implement and maintain appropriate source control and/or treatment BMPs as soon as possible. Address the problems within 10 days of the date the discharge exceeded the benchmark. If installation of necessary treatment BMPs is not feasible within 10 days, Ecology may approve additional time when the Permittee requests an extension within the initial 10-day response period
3. Document BMP implementation and maintenance in the site log book.
4. Continue to sample discharges daily until one of the following is true:
 - Turbidity is 25 NTU (or lower).

- Transparency is 33 cm (or greater).
- Compliance with the water quality limit for turbidity is achieved.
 - 1 - 5 NTU over background turbidity, if background is less than 50 NTU
 - 1% - 10% over background turbidity, if background is 50 NTU or greater
- The discharge stops or is eliminated.

pH Sampling (4.2.2)

pH monitoring is required for “Significant concrete work” (i.e. greater than 1000 cubic yards poured concrete or recycled concrete over the life of the project). The use of engineered soils (soil amendments including but not limited to Portland cement-treated base [CTB], cement kiln dust [CKD] or fly ash) also requires pH monitoring.

For significant concrete work, pH sampling will start the first day concrete is poured and continue until it is cured, typically three (3) weeks after the last pour.

For engineered soils and recycled concrete, pH sampling begins when engineered soils or recycled concrete are first exposed to precipitation and continues until the area is fully stabilized.

If the measured pH is 8.5 or greater, the following measures will be taken:

1. Prevent high pH water from entering storm sewer systems or surface water.
2. Adjust or neutralize the high pH water to the range of 6.5 to 8.5 su using appropriate technology such as carbon dioxide (CO₂) sparging (liquid or dry ice).
3. Written approval will be obtained from Ecology prior to the use of chemical treatment other than CO₂ sparging or dry ice.

Method for sampling pH:

Check the analysis method you will use:

Table 8 – pH Sampling Method

	pH meter
	pH test kit
	Wide range pH indicator paper

Discharges to 303(d) or Total Maximum Daily Load (TMDL) Waterbodies (5.0)

303(d) Listed Waterbodies (5.1)

The 303(d) status is listed on the Water Quality Atlas: <https://ecology.wa.gov/Water-Shorelines/Water-quality/Water-improvement/Assessment-of-state-waters-303d>

Circle the applicable answer, if necessary:

Is the receiving water 303(d) (Category 5) listed for turbidity, fine sediment, phosphorus, or pH?

Yes No

List the impairment(s):

The receiving waterbody, insert waterbody name, is impaired for: insert impairment. All stormwater and dewatering discharges from the site are subject to an **effluent limit** of 8.5 su for pH and/or 25 NTU for turbidity.

If yes, discharges must comply with applicable effluent limitations in S8.C and S8.D of the CSWGP.

Describe the method(s) for 303(d) compliance:

List and describe BMPs:

TMDL Waterbodies (5.2)

Waste Load Allocation for CWSGP discharges:

Describe the method(s) for TMDL compliance:

List and describe BMPs:

Discharges to TMDL receiving waterbodies will meet in-stream water quality criteria at the point of discharge.
--

The Construction Stormwater General Permit Proposed New Discharge to an Impaired Water Body form is included in Appendix F.

Reporting and Record Keeping (6.0)

Record Keeping (6.1)

This section does not need to be filled out. It is a list of reminders for the permittee.

Site Log Book (6.1.1)

A site log book will be maintained for all on-site construction activities and will include:

- A record of the implementation of the SWPPP and other permit requirements
- Site inspections
- Sample logs

Records Retention (6.1.2)

Records will be retained during the life of the project and for a minimum of three (3) years following the termination of permit coverage in accordance with Special Condition S5.C of the CSWGP.

Permit documentation to be retained on-site:

- CSWGP
- Permit Coverage Letter
- SWPPP
- Site Log Book

Permit documentation will be provided within 14 days of receipt of a written request from Ecology. A copy of the SWPPP or access to the SWPPP will be provided to the public when requested in writing in accordance with Special Condition S5.G.2.b of the CSWGP.

Updating the SWPPP (6.1.3)

The SWPPP will be modified if:

- Found ineffective in eliminating or significantly minimizing pollutants in stormwater discharges from the site.
- There is a change in design, construction, operation, or maintenance at the construction site that has, or could have, a significant effect on the discharge of pollutants to waters of the State.

The SWPPP will be modified within seven (7) days if inspection(s) or investigation(s) determine additional or modified BMPs are necessary for compliance. An updated timeline for BMP implementation will be prepared.

Reporting (6.2)

Discharge Monitoring Reports (6.2.1)

Select and retain applicable paragraph.

Cumulative soil disturbance is less than one (1) acre; therefore, Discharge Monitoring Reports (DMRs) will not be submitted to Ecology because water quality sampling is not being conducted at the site.

Or

Cumulative soil disturbance is one (1) acre or larger; therefore, Discharge Monitoring Reports (DMRs) will be submitted to Ecology monthly. If there was no discharge during a given monitoring period the DMR will be submitted as required, reporting “No Discharge”. The DMR due date is fifteen (15) days following the end of each calendar month.

DMRs will be reported online through Ecology’s WQWebDMR System.

To sign up for WQWebDMR go to:

<https://www.ecology.wa.gov/Regulations-Permits/Guidance-technical-assistance/Water-quality-permits-guidance/WQWebPortal-guidance>

Notification of Noncompliance (6.2.2)

If any of the terms and conditions of the permit is not met, and the resulting noncompliance may cause a threat to human health or the environment, the following actions will be taken:

1. Ecology will be notified within 24-hours of the failure to comply by calling the applicable Regional office ERTS phone number (Regional office numbers listed below).
2. Immediate action will be taken to prevent the discharge/pollution or otherwise stop or correct the noncompliance. If applicable, sampling and analysis of any noncompliance will be repeated immediately and the results submitted to Ecology within five (5) days of becoming aware of the violation.
3. A detailed written report describing the noncompliance will be submitted to Ecology within five (5) days, unless requested earlier by Ecology.

Specific information to be included in the noncompliance report is found in Special Condition S5.F.3 of the CSWGP.

Anytime turbidity sampling indicates turbidity is 250 NTUs or greater, or water transparency is 6 cm or less, the Ecology Regional office will be notified by phone within 24 hours of analysis as required by Special Condition S5.A of the CSWGP.

- Central Region at (509) 575-2490 for Benton, Chelan, Douglas, Kittitas, Klickitat, Okanogan, or Yakima County
- Eastern Region at (509) 329-3400 for Adams, Asotin, Columbia, Ferry, Franklin, Garfield, Grant, Lincoln, Pend Oreille, Spokane, Stevens, Walla Walla, or Whitman County
- Northwest Region at (425) 649-7000 for Island, King, Kitsap, San Juan, Skagit, Snohomish, or Whatcom County
- Southwest Region at (360) 407-6300 for Clallam, Clark, Cowlitz, Grays Harbor, Jefferson, Lewis, Mason, Pacific, Pierce, Skamania, Thurston, or Wahkiakum

Include the following information:

1. Your name and / Phone number
2. Permit number
3. City / County of project
4. Sample results
5. Date / Time of call
6. Date / Time of sample
7. Project name

In accordance with Special Condition S4.D.5.b of the CSWGP, the Ecology Regional office will be notified if chemical treatment other than CO₂ sparging is planned for adjustment of high pH water.

Appendix/Glossary

A. Site Map

The site map must meet the requirements of Special Condition S9.E of the CSWGP

B. BMP Detail

Insert BMPs specification sheets here.

Download BMPs from the Ecology Construction Stormwater website at:

<https://www.ecology.wa.gov/Regulations-Permits/Guidance-technical-assistance/Stormwater-permittee-guidance-resources/Stormwater-manuals>

C. Correspondence

Ecology

EPA

Local Government

D. Site Inspection Form

Create your own or download Ecology's template:

<https://www.ecology.wa.gov/Regulations-Permits/Permits-certifications/Stormwater-general-permits/Construction-stormwater-permit>

E. Construction Stormwater General Permit (CSWGP)

Download CSWGP: <https://www.ecology.wa.gov/Regulations-Permits/Permits-certifications/Stormwater-general-permits/Construction-stormwater-permit>

F. 303(d) List Waterbodies / TMDL Waterbodies Information

Proposed New Discharge to an Impaired Water Body form
SWPPP Addendum addressing impairment

G. Contaminated Site Information

Administrative Order

Sanitary Discharge Permit

Soil Management Plan

Soil and Groundwater Reports

Maps and Figures Depicting Contamination

H. Engineering Calculations

Appendix E

Operations and Maintenance Manual

Table V-A.5: Maintenance Standards - Catch Basins

Maintenance Component	Defect	Conditions When Maintenance is Needed	Results Expected When Maintenance is performed
General	Trash & Debris	Trash or debris which is located immediately in front of the catch basin opening or is blocking inletting capacity of the basin by more than 10%. Trash or debris (in the basin) that exceeds 60 percent of the sump depth as measured from the bottom of basin to invert of the lowest pipe into or out of the basin, but in no case less than a minimum of six inches clearance from the debris surface to the invert of the lowest pipe. Trash or debris in any inlet or outlet pipe blocking more than 1/3 of its height. Dead animals or vegetation that could generate odors that could cause complaints or dangerous gases (e.g., methane).	No Trash or debris located immediately in front of catch basin or on grate opening. No trash or debris in the catch basin. Inlet and outlet pipes free of trash or debris. No dead animals or vegetation present within the catch basin.
	Sediment	Sediment (in the basin) that exceeds 60 percent of the sump depth as measured from the bottom of basin to invert of the lowest pipe into or out of the basin, but in no case less than a minimum of 6 inches clearance from the sediment surface to the invert of the lowest pipe.	No sediment in the catch basin
	Structure Damage to Frame and/or Top Slab	Top slab has holes larger than 2 square inches or cracks wider than 1/4 inch. (Intent is to make sure no material is running into basin). Frame not sitting flush on top slab, i.e., separation of more than 3/4 inch of the frame from the top slab. Frame not securely attached	Top slab is free of holes and cracks. Frame is sitting flush on the riser rings or top slab and firmly attached.
	Fractures or Cracks in Basin Walls/ Bottom	Maintenance person judges that structure is unsound. Grout fillet has separated or cracked wider than 1/2 inch and longer than 1 foot at the joint of any inlet/outlet pipe or any evidence of soil particles entering catch basin through cracks.	Basin replaced or repaired to design standards. Pipe is regouted and secure at basin wall.
	Settlement/ Mis-alignment	If failure of basin has created a safety, function, or design problem.	Basin replaced or repaired to design standards.
	Vegetation	Vegetation growing across and blocking more than 10% of the basin opening. Vegetation growing in inlet/outlet pipe joints that is more than six inches tall and less than six inches apart.	No vegetation blocking opening to basin. No vegetation or root growth present.
	Contamination and Pollution	See Table V-A.1: Maintenance Standards - Detention Ponds	No pollution present.
Catch Basin Cover	Cover Not in Place	Cover is missing or only partially in place. Any open catch basin requires maintenance.	Cover/grate is in place, meets design standards, and is secured
	Locking Mechanism Not Working	Mechanism cannot be opened by one maintenance person with proper tools. Bolts into frame have less than 1/2 inch of thread.	Mechanism opens with proper tools.
	Cover Difficult to Remove	One maintenance person cannot remove lid after applying normal lifting pressure. (Intent is keep cover from sealing off access to maintenance.)	Cover can be removed by one maintenance person.
Ladder	Ladder Rungs Unsafe	Ladder is unsafe due to missing rungs, not securely attached to basin wall, misalignment, rust, cracks, or sharp edges.	Ladder meets design standards and allows maintenance person safe access.
Metal Grates (If Applicable)	Grate opening Unsafe	Grate with opening wider than 7/8 inch.	Grate opening meets design standards.
	Trash and Debris	Trash and debris that is blocking more than 20% of grate surface inletting capacity.	Grate free of trash and debris.
	Damaged or Missing.	Grate missing or broken member(s) of the grate.	Grate is in place, meets the design standards, and is installed and aligned with the flow path.

Table V-A.17: Maintenance Standards - Coalescing Plate Oil/Water Separators

Maintenance Component	Defect	Condition When Maintenance is Needed	Results Expected When Maintenance is Performed
General	Monitoring	Inspection of discharge water for obvious signs of poor water quality.	Effluent discharge from vault should be clear with no thick visible sheen.
	Sediment Accumulation	Sediment depth in bottom of vault exceeds 6-inches in depth and/or visible signs of sediment on plates.	No sediment deposits on vault bottom and plate media, which would impede flow through the vault and reduce separation efficiency.
	Trash and Debris Accumulation	Trash and debris accumulated in vault, or pipe inlet/outlet, floatables and non-floatables.	Trash and debris removed from vault, and inlet/outlet piping.
	Oil Accumulation	Oil accumulation that exceeds 1-inch at the water surface.	Oil is extracted from vault using vactoring methods. Coalescing plates are cleaned by thoroughly rinsing and flushing. Should be no visible oil depth on water.
	Damaged Coalescing Plates	Plate media broken, deformed, cracked and/or showing signs of failure.	A portion of the media pack or the entire plate pack is replaced depending on severity of failure.
	Damaged Pipes	Inlet or outlet piping damaged or broken and in need of repair.	Pipe repaired and or replaced.
	Baffles	Baffles corroding, cracking, warping and/or showing signs of failure as determined by maintenance/inspection person.	Baffles repaired or replaced to specifications.
	Vault Structure Damage - Includes Cracks in Walls, Bottom, Damage to Frame and/or Top Slab	Cracks wider than 1/2-inch or evidence of soil particles entering the structure through the cracks, or maintenance/inspection personnel determine that the vault is not structurally sound. Cracks wider than 1/2-inch at the joint of any inlet/outlet pipe or evidence of soil particles entering through the cracks.	Vault replaced or repairs made so that vault meets design specifications and is structurally sound. Vault repaired so that no cracks exist wider than 1/4-inch at the joint of the inlet/outlet pipe.
	Access Ladder Damaged	Ladder is corroded or deteriorated, not functioning properly, not securely attached to structure wall, missing rungs, cracks, and misaligned.	Ladder replaced or repaired and meets specifications, and is safe to use as determined by inspection personnel.

Table V-A.18: Maintenance Standards - Catch Basin Inserts

Maintenance Component	Defect	Conditions When Maintenance is Needed	Results Expected When Maintenance is Performed
General	Sediment Accumulation	When sediment forms a cap over the insert media of the insert and/or unit.	No sediment cap on the insert media and its unit.
	Trash and Debris Accumulation	Trash and debris accumulates on insert unit creating a blockage/restriction.	Trash and debris removed from insert unit. Runoff freely flows into catch basin.
	Media Insert Not Removing Oil	Effluent water from media insert has a visible sheen.	Effluent water from media insert is free of oils and has no visible sheen.
	Media Insert Water Saturated	Catch basin insert is saturated with water and no longer has the capacity to absorb.	Remove and replace media insert
	Media Insert-Oil Saturated	Media oil saturated due to petroleum spill that drains into catch basin.	Remove and replace media insert.
	Media Insert Use Beyond Product Life	Media has been used beyond the typical average life of media insert product.	Remove and replace media at regular intervals, depending on insert product.

Table V-A.19: Maintenance Standards - Media Filter Drain (MFD)

Maintenance Component	Defect	Conditions When Maintenance is Needed	Results Expected When Maintenance is Performed
General	Sediment accumulation on grass filter strip	Sediment depth exceeds 2 inches or creates uneven grading that interferes with sheet flow.	Remove sediment deposits on grass treatment area of the embankment. When finished, embankment should be level from side to side and drain freely toward the toe of the embankment slope. There should be no areas of standing water once inflow has ceased.
	No-vegetation	Flow spreader is uneven or clogged so that flows are not uniformly distributed over entire embankment width.	Level the spreader and clean to spread flows evenly over entire embankment width.